





Parte externa llave de paso **CHERIE_CX003310**

MODELO **CX003310**

Parte externa llave de paso, sin parte empotrada, para art. ZA003320 - ZA003321, ZA003310 - ZA003311



ACABADOS DISPONIBLES

- 
6T 6T Cromo/Negro Mate
- 
7C 7C Oro/Negro Mate
- 
7D 7D Niquel Brillo/Negro Mate
- 
7E 7E Oro Rosa/Negro Mate

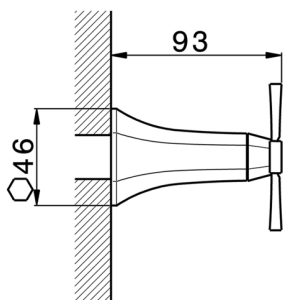

CARACTERÍSTICAS

Instalación	Empotrado
Empotrado 4	ZA003311
	ZA003310
	ZA003321
	ZA003320



Parte empotrada llave de paso 3/4" EMPOTRADO_ZA003311

MODELO **ZA003311**

Parte empotrada llave de paso 3/4", apert. en sentido agujas del reloj

ACABADOS DISPONIBLES



04 04 Sin acabado

CARACTERÍSTICAS

Empotrado **1**

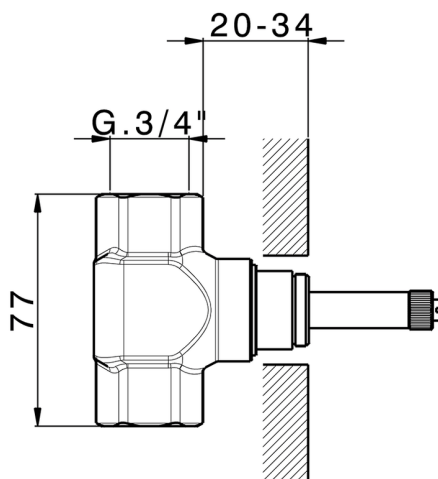

Parte empotrada llave de paso 3/4" EMPOTRADO_ZA003310

MODELO **ZA003310**

Parte empotrada llave de paso 3/4", Apert. sentido contrario agujas del reloj

ACABADOS DISPONIBLES



04 04 Sin acabado

CARACTERÍSTICAS

Empotrado **1**

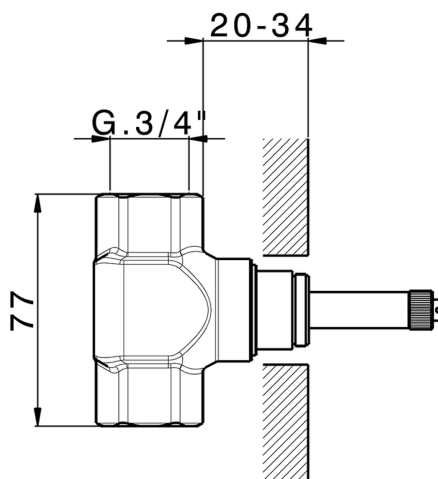

Parte empotrada llave de paso 1/2" EMPOTRADO_ZA003321

MODELO **ZA003321**

Parte empotrada llave de paso 1/2", apert. en sentido agujas del reloj

ACABADOS DISPONIBLES



04 04 Sin acabado

CARACTERÍSTICAS

Empotrado **1**

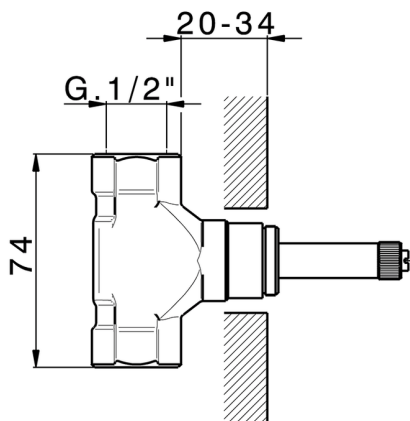

Parte empotrada llave de paso 1/2" EMPOTRADO_ZA003320

MODELO **ZA003320**

Parte empotrada llave de paso 1/2", apert. sentido contrario agujas del reloj

ACABADOS DISPONIBLES



04 04 Sin acabado

CARACTERÍSTICAS

Empotrado **1**

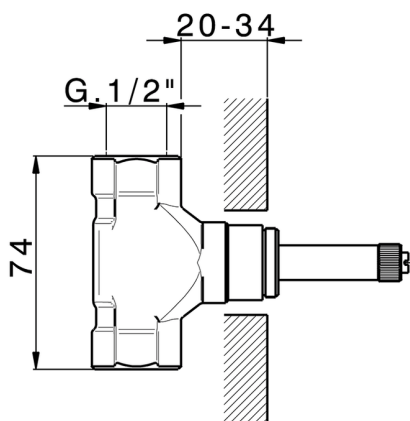

2024-11-23