





## Conjunto ducha duplex VITA\_VI003050

MODELO **VI003050**

Conjunto ducha duplex, soporte duchita mural, duchita una función Ø 23 mm de Latón, flexible liso SUPREME 150 cm

### ACABADOS DISPONIBLES

-  **21** 21 Cromo
-  **2Q** 2Q Black Titanium
-  **40** 40 Negro Mate
-  **4Q** 4Q Blanco Mate

### CARACTERÍSTICAS

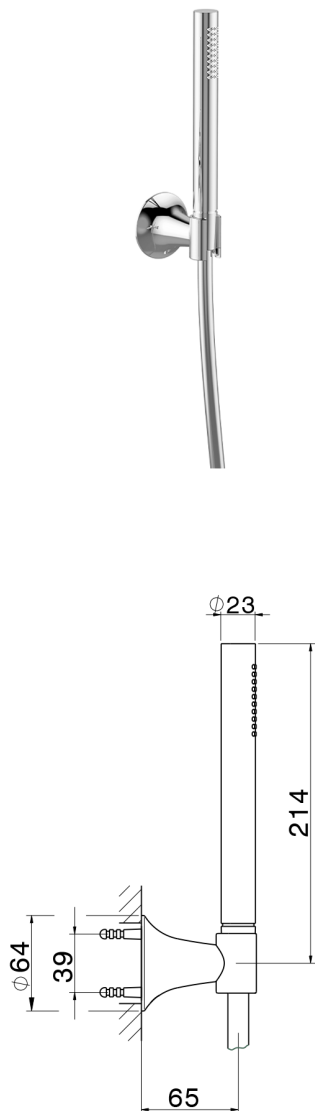

## Conjunto ducha duplex VITA\_VI003050

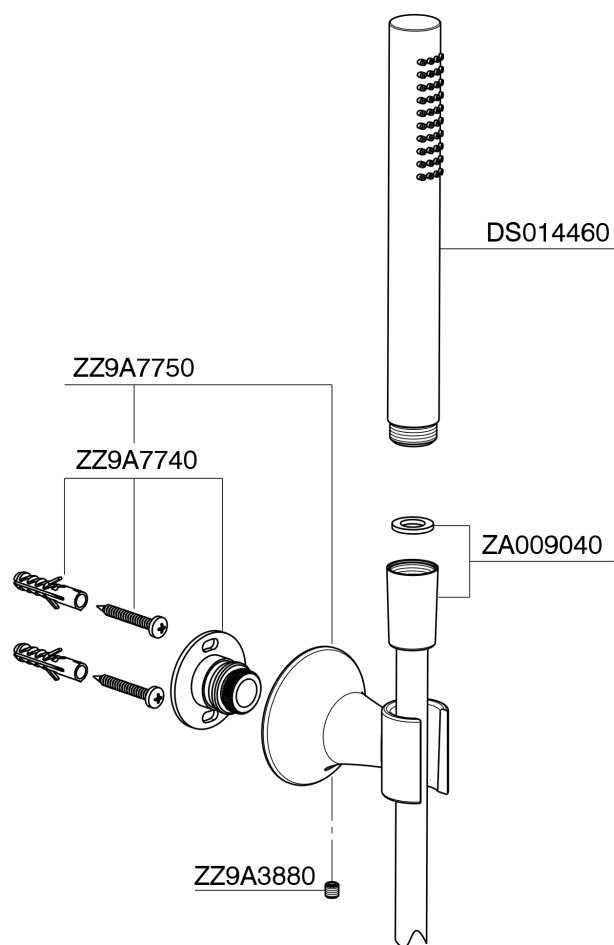

VI003050

<https://es.cisal.it/conjunto-ducha-duplex-vita-vi003050>

2026-04-30