

## Columna ducha 2 funciones BARCELONA\_BA004051

MODELO **BA004051**

Columna ducha 2 funciones, desviador 2 salidas, columna telescópica, con soporte duchita fijo, duchita una función minimal de Latón, rociador redondo Ø 200 mm, flexible PVC 150 cm

ACABADOS DISPONIBLES



**21** 21 Cromo



**2A** 2A Niquel Satinado Cepillado



**40** 40 Negro Mate

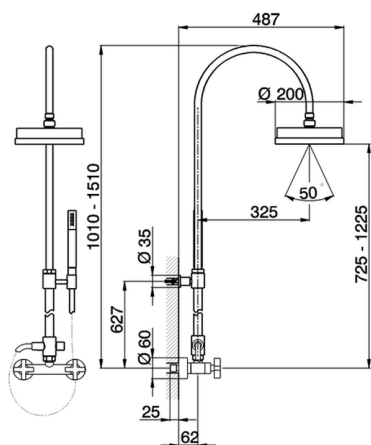

CARACTERÍSTICAS



## Columna ducha 2 funciones BARCELONA\_BA004051

# cisal

**BA 00405 1**

da Febbraio 2009 - from February 2009  
ab Februar 2009 - de Février 2009

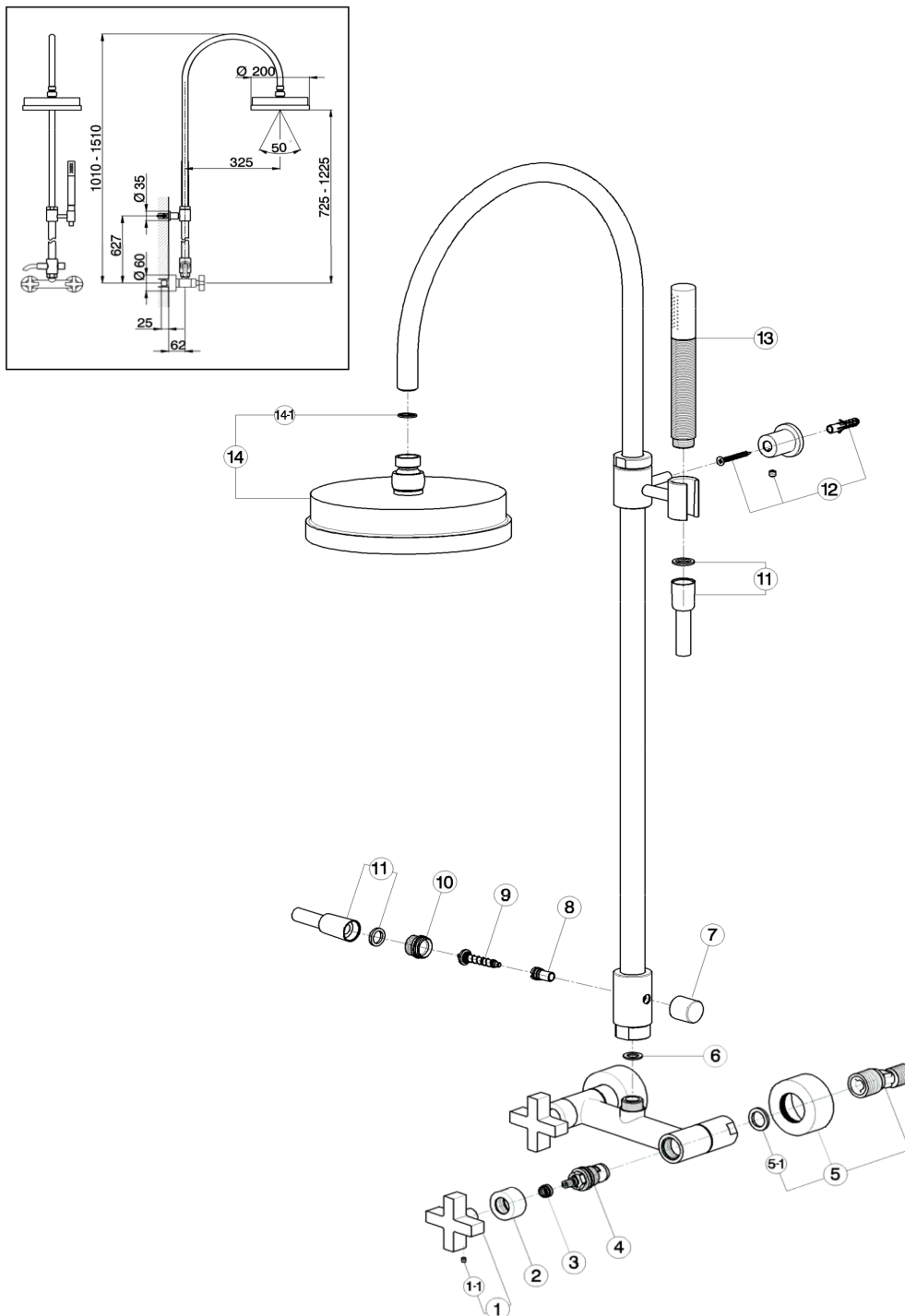

BA004051

<https://es.cisal.it/columna-ducha-2-funciones-barcelona-ba004051>

## Columna ducha 2 funciones BARCELONA\_BA004051

# cisal

**BA 00405 1**

 da Febbraio 2009 - from February 2009  
 ab Februar 2009 - de Février 2009

NR.	DESCRIZIONE DESCRIPTION BESCREIBUNG DESCRIPTION	N.CODICE CODE NO. WERSKNR. NR.CODE	NR.	DESCRIZIONE DESCRIPTION BESCREIBUNG DESCRIPTION	N.CODICE CODE NO. WERSKNR. NR.CODE	NR.	DESCRIZIONE DESCRIPTION BESCREIBUNG DESCRIPTION	N.CODICE CODE NO. WERSKNR. NR.CODE
1	Maniglia BA per monofori Croisillon BA pour mélangeur monotrou Handle BA for single hole mixer Griff BA fuer Einloch Batterien	ZZ932890	7	Pomolo per deviazione Pommeau pour inverseur Knob for diverter Zugknopf Umsteller	ZZ933290	14-1	Guarnizione fibra 18,5x11x2 Joint en fibre 18,5x11x2 Gasket rubber 18,5x11x2 Fiberdichtung 18,5x11x2	ZZ927140
1-1	Grano punta piana inox M.4x4 Vis speciale inox M.4x4 Screw stainless steel M.4x4 Madenschraube M.4x4	ZZ933280	8	Corpo deviazione automatica Corps inverseur automatique Body for automatic diverter Körper für automatische Umstellung	ZZ949860			
2	Cappuccio coprivotone BA Rosace couvre tete BA Escutcheon BA Abdeckkappe BA	ZZ933270	9	Asta deviazione completa Tige inverseur complète Complete diverting rod Umstellung	ZZ933140			
3	Riduzione brocciata completa Reduction avec brochage complete Complete broached reduction piece Verkuerzung Raemwerkzeug komplett	ZZ933300	10	Attacco flessibile Raccordo flex Flexible connection Flex Anschluss	ZZ931410			
4	Vitone ceramico 1/2" DX 90° Tete ceramique 1/2" droite 90° Ceramic headvalve 1/2" right 90° Keramikoberteil 1/2" - rechts - 90°	ZZ929070	11	Flessibile D.14x150 1/2" conico x 1/2" Flexible D.14x150 avec raccord 1/2" Hose D.14x150 1/2"x1/2" Schlauch D.14x150 1/2" Konus x 1/2"	ZA009030			
5	Eccentrico con rosone BA Excentrique + rosace BA Excentric ocnnection with escutch. BA S-Anschluss mit Rosette BA	ZZ932980	12	Set installazione asta doccia Set installation colonne de douche Installation set for sliding bar Installationsset für Wandstange	ZZ949870			
5-1	Guarnizione NBR 90 SH. 24x16x2,7 Joint NBR 90 SH. 24x16x2,7 Gasket NBR 90 SH. 24x16x2,7 Dichtung NBR 90 SH. 24x16x2,7	ZZ926890	13	Doccia minimale Douchette minimal Minimal handshower Handbrause minimal	DS014090			
6	Guarnizione fibra 18,5x11x2 Joint en fibre 18,5x11x2 Gasket rubber 18,5x11x2 Fiberdichtung 18,5x11x2	ZZ927140	14	Soffione doccia Pomme de douche Headshower Kopfbrause	DS016100			

BA004051

<https://es.cisal.it/columna-ducha-2-funciones-barcelona-ba004051>

2026-06-19