

Lavabo monomando SLIM_SM000730

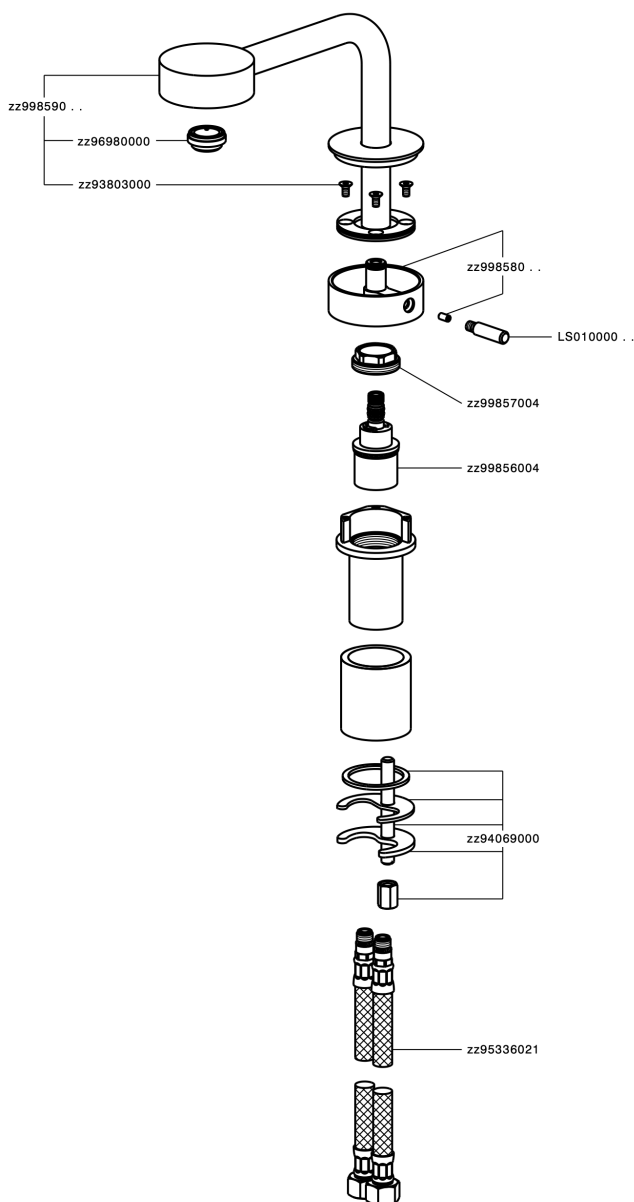

SM000730

<https://es.cisal.it/lavabo-monomando-slim-sm000730>

Parte empotrada termostático ducha 1 salida EMPOTRADO_ZA007301

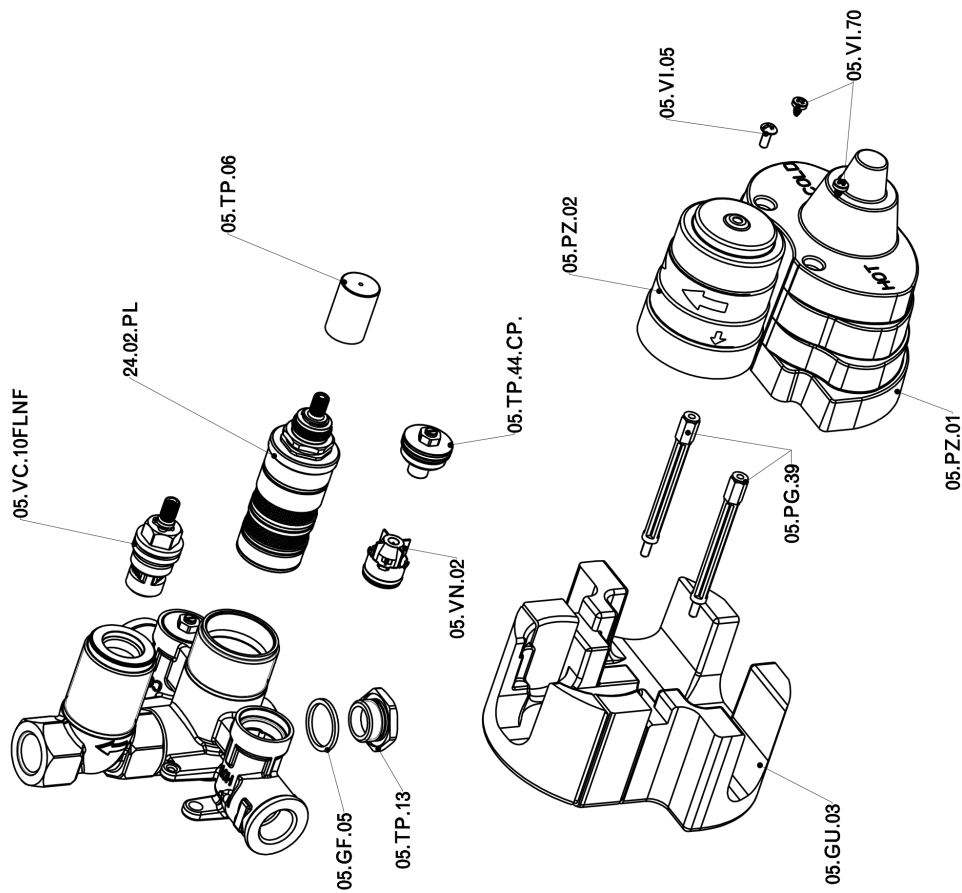

ZA007301

<https://es.cisal.it/parte-empotrada-termostatico-ducha-1-salida-empotrado-za007301>

2025-01-15