





Lavabo monomando SLIM_SM000730



MODELO **SM000730**

Lavabo monomando, sin desagüe automático, latiguillos acero G.3/8"

ACABADOS DISPONIBLES

-  **40** 40 Negro Mate
-  **4Q** 4Q Blanco Mate
-  **6T** 6T Cromo/Negro Mate
-  **7D** 7D Niquel Brillo/Negro Mate

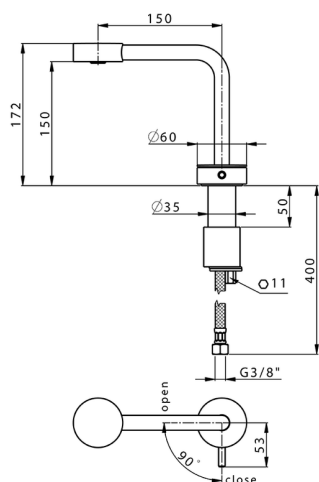

CARACTERÍSTICAS

Recambio Cartucho **ZZ99856004**

Cartucho Monomando Progresivo 27mm

Empotrado 1 **ZA007301**



Lavabo monomando SLIM_SM000730

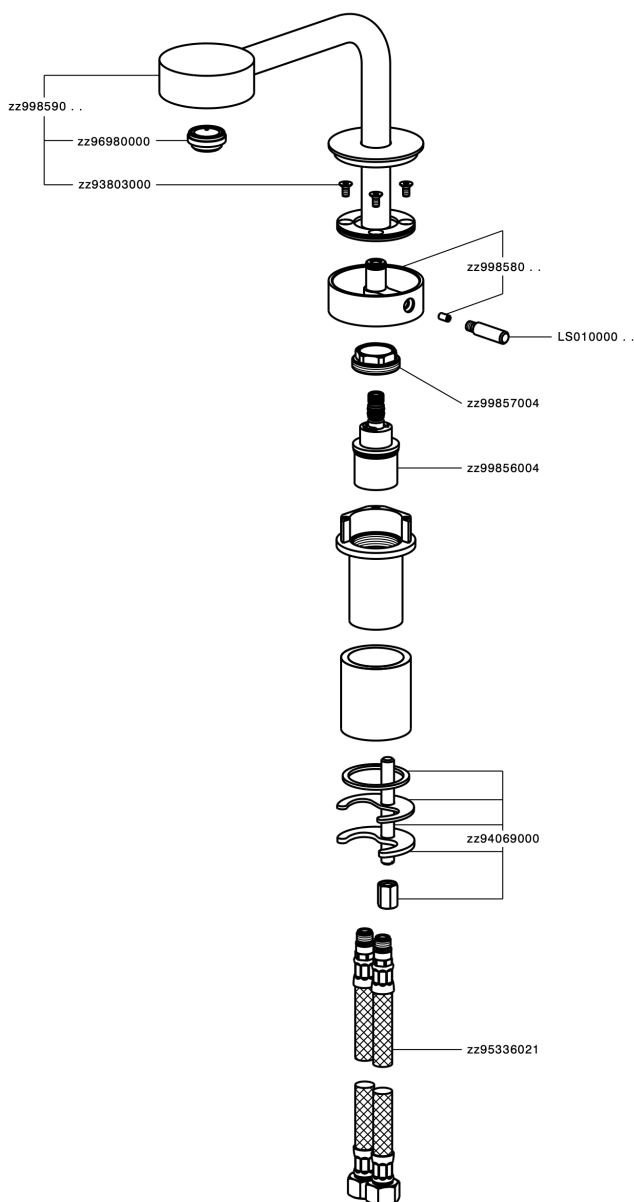

SM000730

<https://es.cisal.it/lavabo-monomando-slim-sm000730>

Parte empotrada termostático ducha 1 salida EMPOTRADO_ZA007301

MODELO **ZA007301**

Parte empotrada termostático ducha 1 salida, llave de paso con salida 1/2", sin parte externa

ACABADOS DISPONIBLES



CARACTERÍSTICAS

Recambio Cartucho **24.04A.PP**

Empotrado **1**

Cartucho Termostático Plus P 8X20

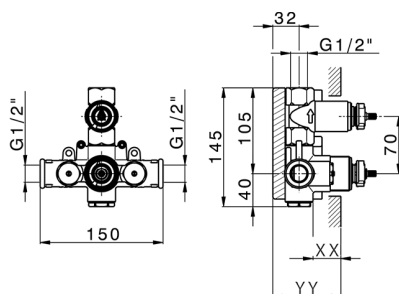

Piastra/Plate/Plaque/Platte/Placa

2-3mm: XX 25-40 YY 76-91

10mm: XX 16-31 YY 65-80



Termostático

El termostático Cisal es tu gestor personal del agua, ayudándote a manejar, controlar y ahorrar agua y energía.



2024-12-04