

## Bidé monomando MARBLE X32\_X6000564

MODELO **X6000564**

Bidé monomando, sin desagüe automático, latiguillos acero G.3/8", con palanca de mármol, Inox AISI 316L

ACABADOS DISPONIBLES



**5X** 5X Acero Cepillado/Mármol Negro Marquina



CARACTERÍSTICAS

Recambio Cartucho **ZZ96550000**

**Cartucho Monomando 25 mm**

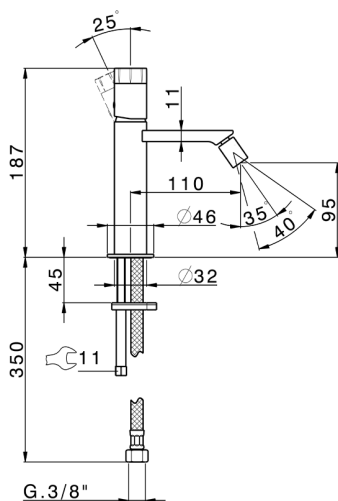

2026-06-20