

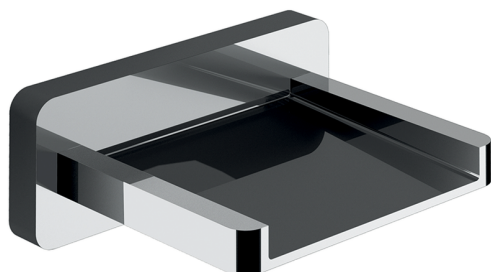

Caño de erogación COMPLEMENTOS_ZA002190

MODELO **ZA002190**

Caño de erogación, chorro cascada, conexión 1/2"
M, L. 138 mm



ACABADOS DISPONIBLES

-  **21** 21 Cromo
-  **2B** 2B Niquel Brillo
-  **2F** 2F Niquel Cepillado

CARACTERÍSTICAS

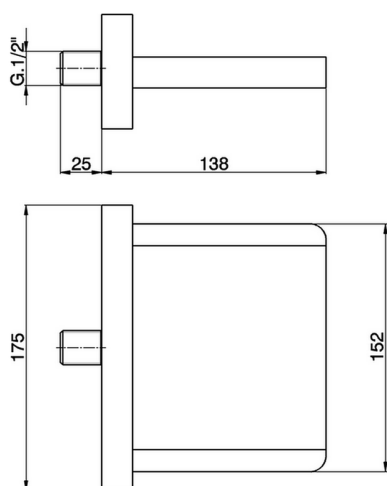

2026-05-01