

Parte externa lavabo de pared SLIM_SM013510

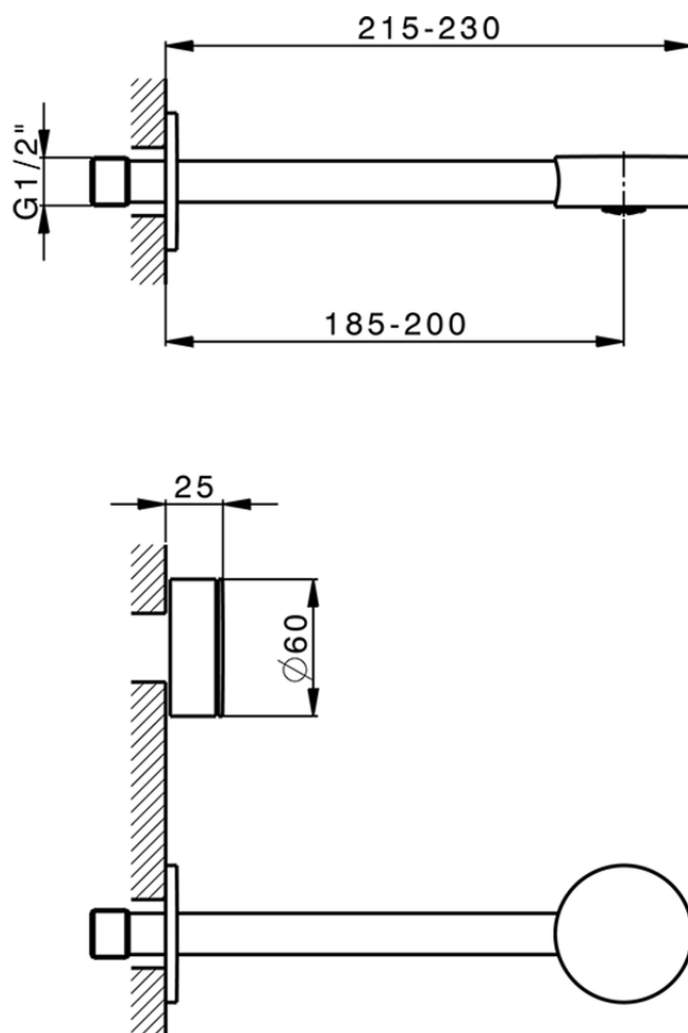

SM013510

<https://es.cisal.it/parte-externa-lavabo-de-pared-slim-sm013510>

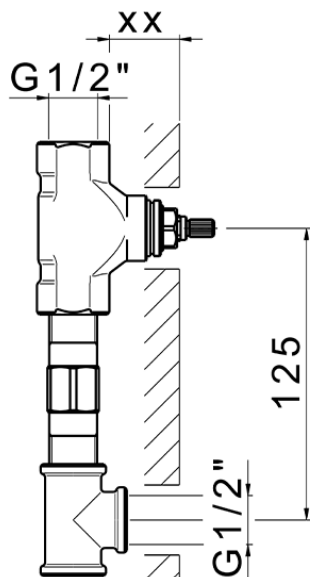

Serie's code	Size XX
CX 1351	20-35
CF 1351	20-35
CX 0331	20-35
CF 0331	20-35
CX 0200	20-35
CF 0200	20-35
BA 1351	20-35
GS 1351	20-35
GL 1351	20-35
MN 1351	20-35
LN 1351	20-35
LV 1351	33-48
LY 1351	33-48
CU 1351	33-48
SM 1351	30-45
AA 1351	10-30
AC 1351	10-30
AR 1351	15-25
PZ 1351	10-30
RG 1351	10-30
TS 1351	10-30
VT 1351	10-30
CS 1351	10-30
WA 1351	45-68
X1 1351	33-45
X2 1351	33-45
X3 1351	33-45
X4 1351	33-45
X5 1351	33-45
RI 1351	20-35
RM 1351	20-35

Limiti di tolleranza superficie piastrelle
 Adjustment limits for finished tile surface
 Limites de tolérance surface carrelage
 Fliesenoberfläche
 Superficie del azulejo

ZA033510

<https://es.cisal.it/parte-empotrada-lavabo-de-pared-empotrado-za033510>

2024-11-21