

Parte externa monomando bañera de suelo LINEAVIVA_LV014200

LV014200

<https://es.cisal.it/parte-externa-monomando-banera-de-suelo-lineaviva-lv014200>

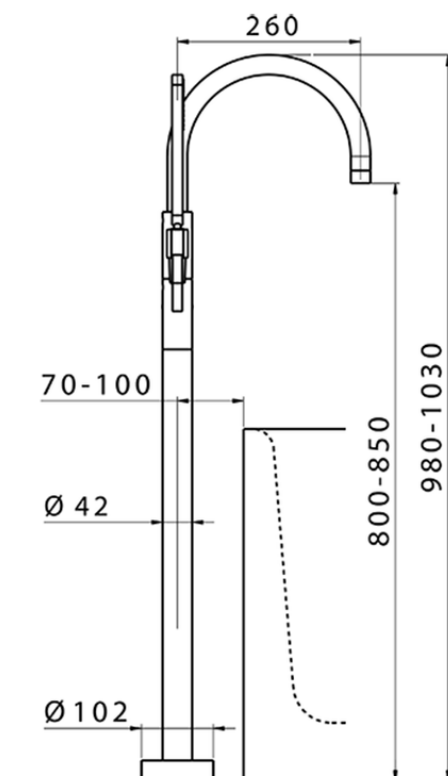

ZA004510

<https://es.cisal.it/parte-empotrada-monomando-free-standing-empotrado-za004510>

2026-06-19