

**Parte externa monomando bañera de suelo LINEAVIVA\_LV014200**

LV014200

<https://es.cisal.it/parte-externa-monomando-banera-de-suelo-lineaviva-lv014200>

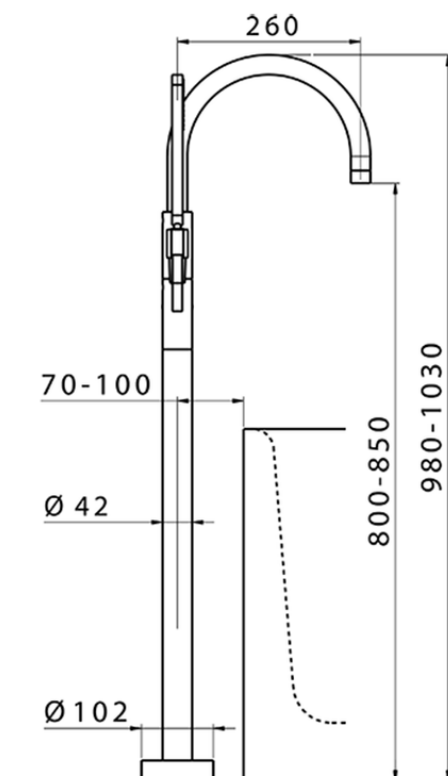
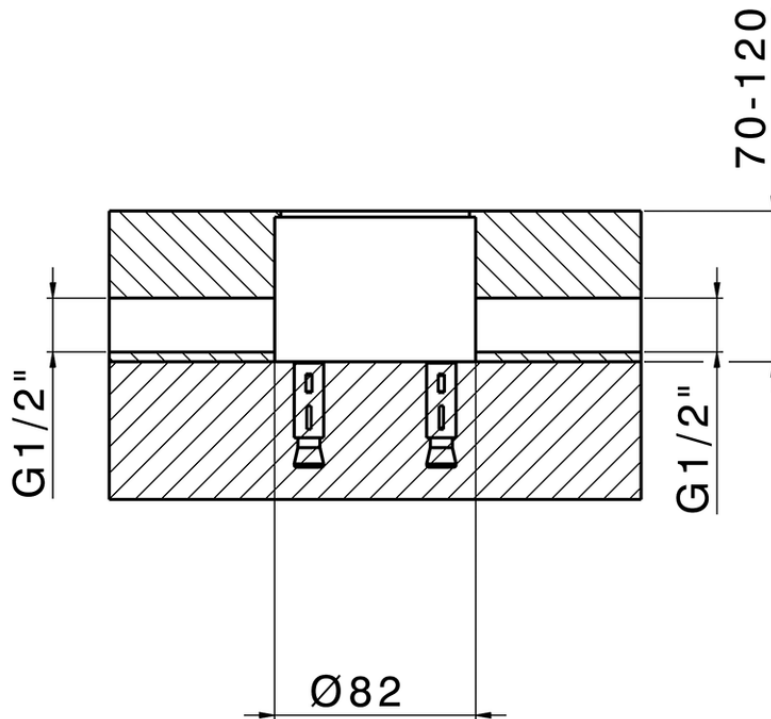

ZA004510

<https://es.cisal.it/parte-empotrada-monomando-free-standing-empotrado-za004510>

2026-04-29