

Parte externa termostático ducha emp. 3 salidas SMOOTH X32_X3018200

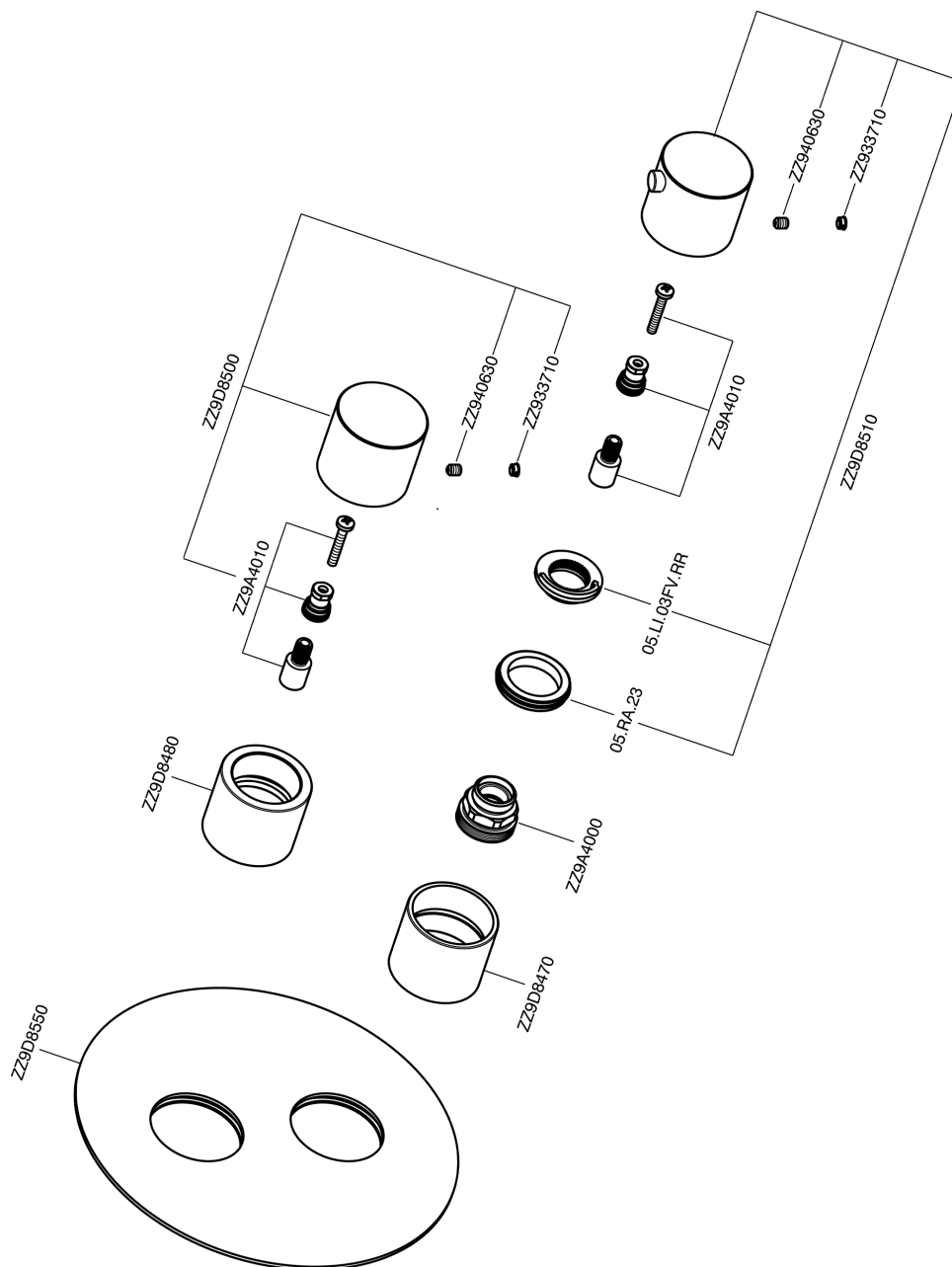

X3018200

<https://es.cisal.it/parte-externa-termostatico-ducha-emp-3-salidas-smooth-x32-x3018200>

Parte empotrada termostático ducha 3 salidas EMPOTRADO_ZA018201

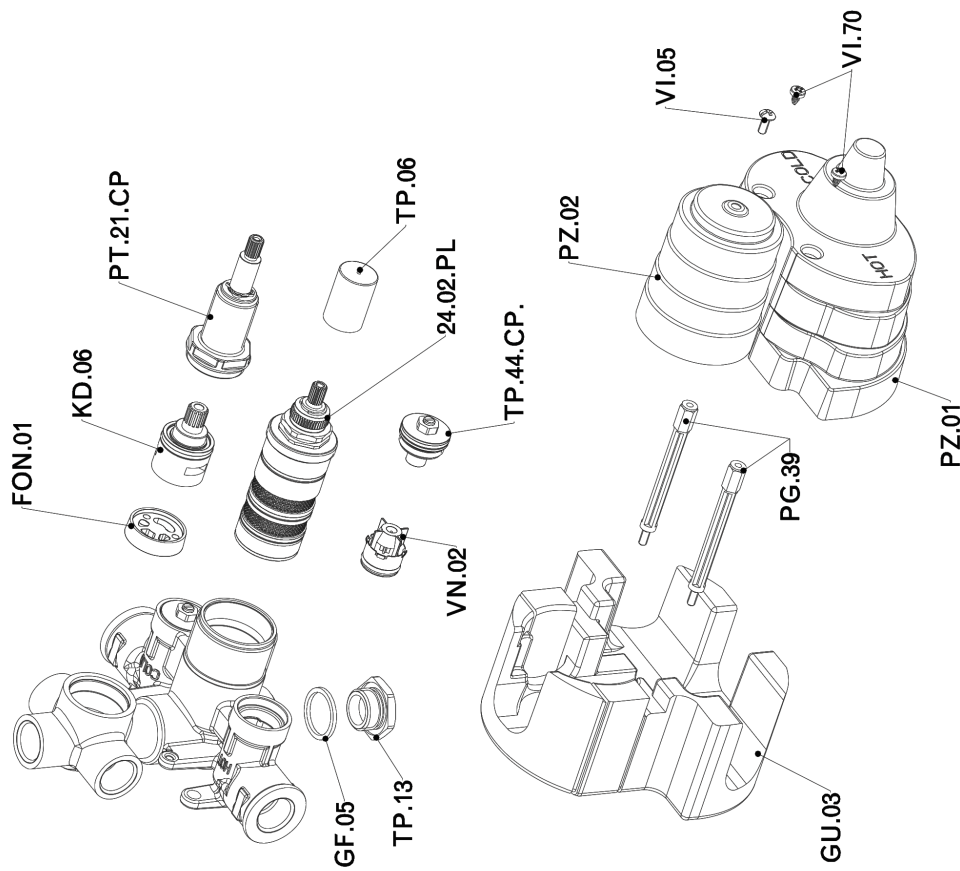

ZA018201

<https://es.cisal.it/parte-empotrada-termostatico-ducha-3-salidas-empotrado-za018201>

2026-04-29