

Parte externa termostático ducha emp. 2 salidas CHERIE_CE019100

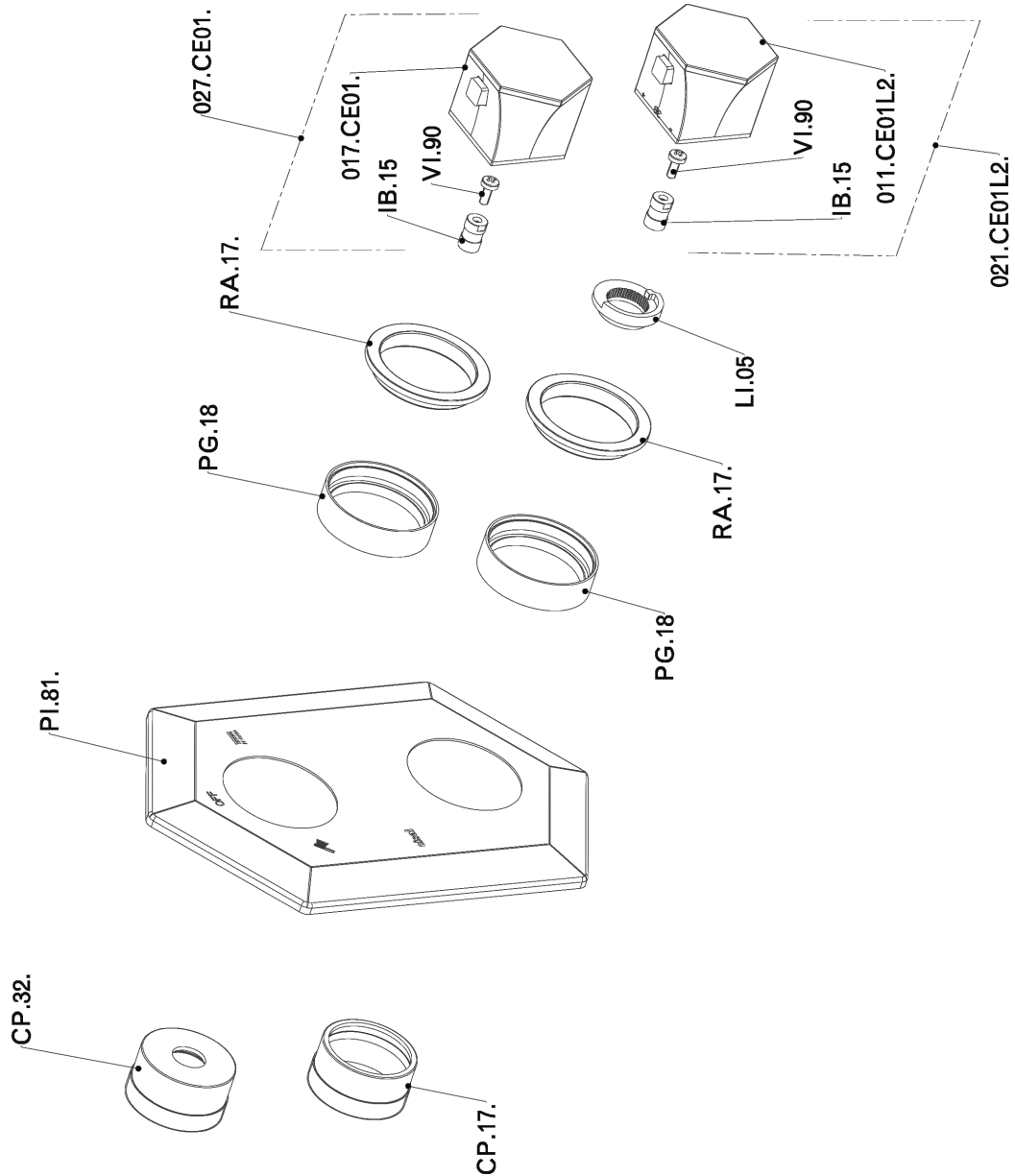

CE019100

<https://es.cisal.it/parte-externa-termostatico-ducha-emp-2-salidas-cherie-ce019100>

Parte empotrada termostático ducha 2 salidas EMPOTRADO_ZA019100

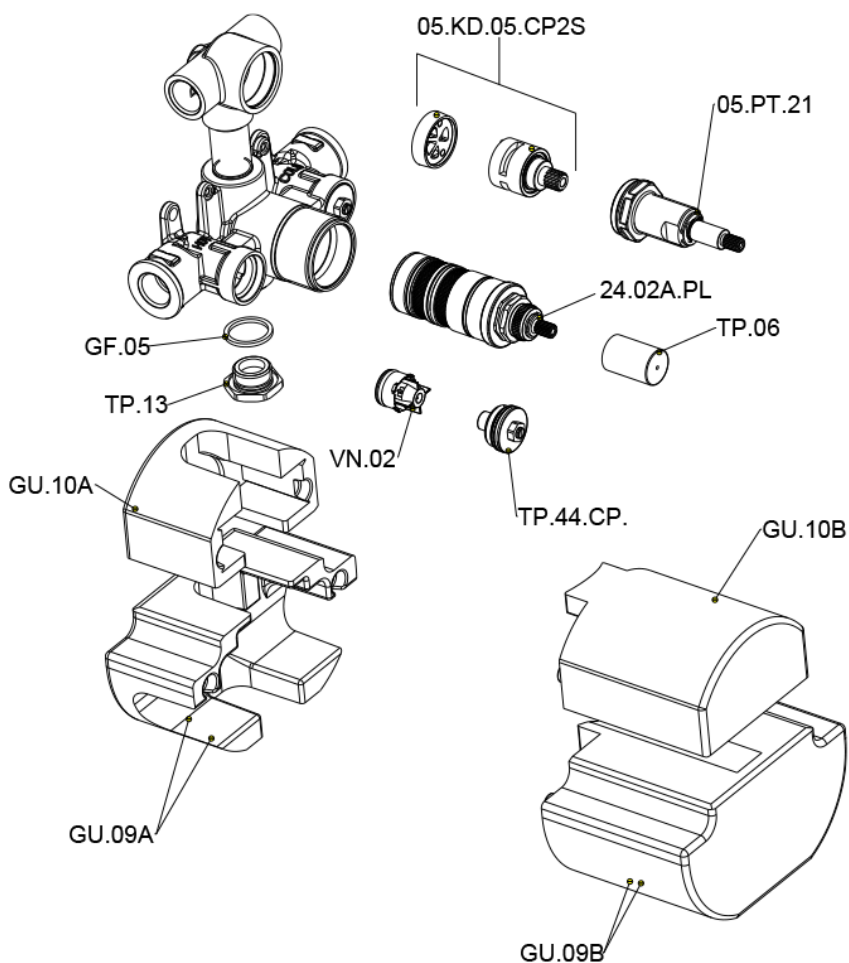

ZA019100

<https://es.cisal.it/parte-empotrada-termostatico-ducha-2-salidas-empotrado-za019100>

2026-06-14