

## Parte externa termostático ducha emp. 1 salida ARCANA TOSCANA\_TS007280



MODELO **TS007280**

Parte externa termostático ducha emp.1 salida,llave de paso,sin parte empotrada,para art.ZA007281

### ACABADOS DISPONIBLES

-  **21** 21 Cromo
-  **24** 24 Oro
-  **26** 26 Cobre Viejo
-  **27** 27 Bronce Viejo
-  **2A** 2A Niquel Satinado Cepillado

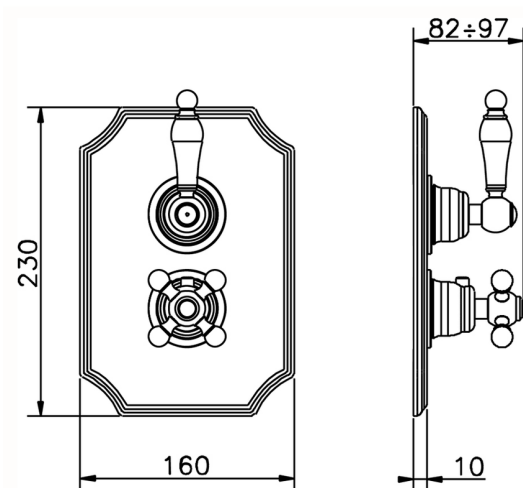

### CARACTERÍSTICAS

Instalación **Empotrado**  
Empotrado 1 **ZA007281**



### Termostático

El termostático Cisal es tu gestor personal del agua, ayudándote a manejar, controlar y ahorrar agua y energía.



## Parte empotrada termostático ducha 1 salida EMPOTRADO\_ZA007281

MODELO **ZA007281**

Parte empotrada termostático ducha 1 salida, llave de paso con salida 1/2", sin parte externa

ACABADOS DISPONIBLES



**04** 04 Sin acabado

CARACTERÍSTICAS

Recambio Cartucho **24.04A.PP**

Empotrado **1**

**Cartucho Termostático Plus P 8X20**

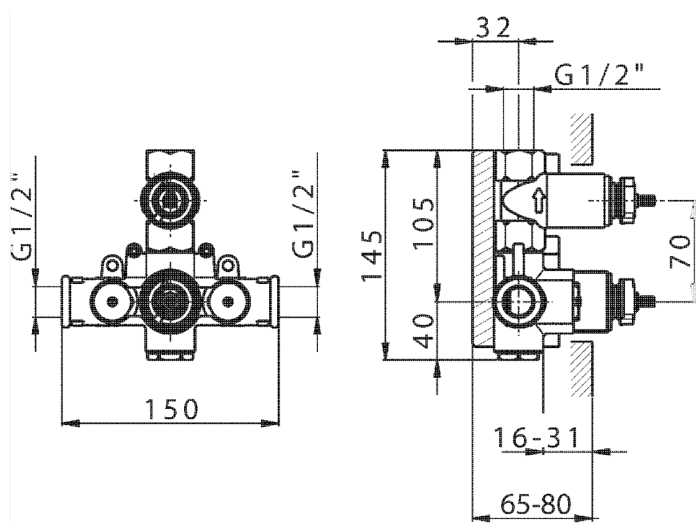

### Termostático

El termostático Cisal es tu gestor personal del agua, ayudándote a manejar, controlar y ahorrar agua y energía.



2026-05-04