







Columna monomando ducha 2 funciones ARCANA EMPRESS_EM004050

MODELO **EM004050**

Columna monomando ducha 2 funciones,desviador 2 salidas,columna telescópica,con soporte duchita fijo,duchita una función Toscana,rociador redondo Ø200 mm de Latón,flexible de Latón 150 cm

ACABADOS DISPONIBLES

-  **21** 21 Cromo
-  **24** 24 Oro
-  **26** 26 Cobre Viejo
-  **27** 27 Bronce Viejo
-  **2A** 2A Niquel Satinado Cepillado
-  **74** 74 Cromo/Oro

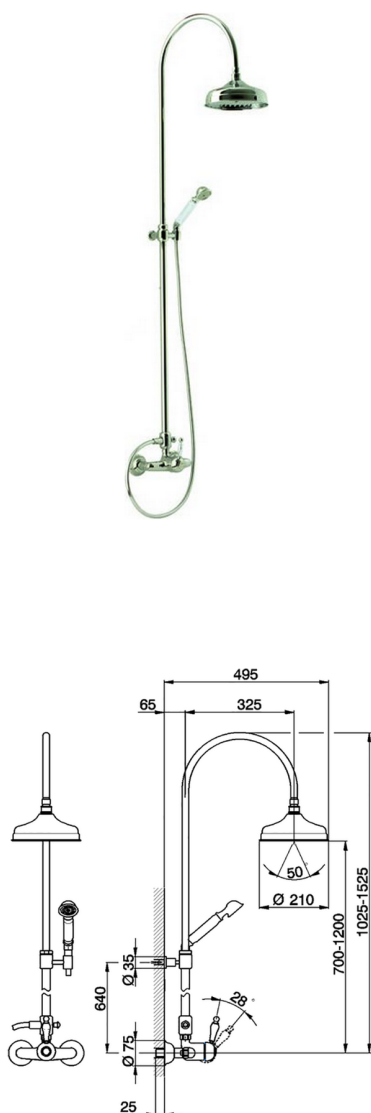

CARACTERÍSTICAS

Recambio Cartucho **ZZ92909000**

Cartucho Monomando 43 mm



Columna monomando ducha 2 funciones ARCANA EMPRESS_EM004050

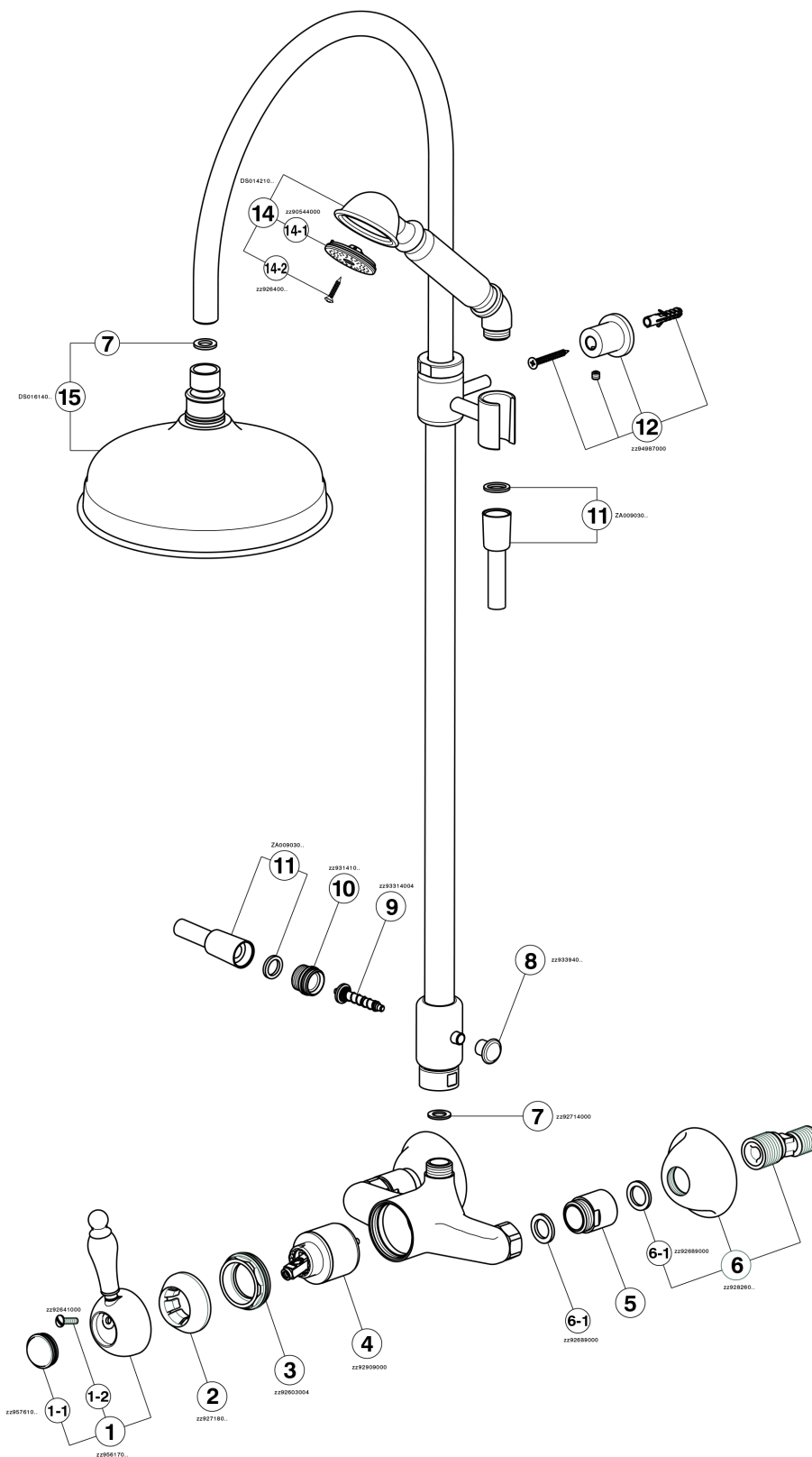

EM004050

<https://es.cisal.it/columna-monomando-ducha-2-funciones-arcana-empress-em004050>

2026-06-16