





Parte externa lavabo de pared LINEAVIVA_LV013510

MODELO **LV013510**

Parte externa lavabo de pared, sin parte empotrada, para art. ZA033511

ACABADOS DISPONIBLES

-  **21** 21 Cromo
-  **2B** 2B Niquel Brillo
-  **2F** 2F Niquel Cepillado
-  **40** 40 Negro Mate
-  **4Q** 4Q Blanco Mate

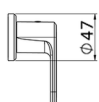
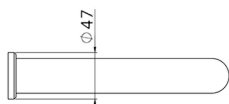
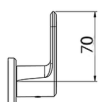
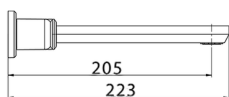
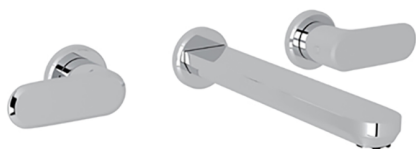

CARACTERÍSTICAS

Instalación **Empotrado**
 Empotrado 1 **ZA033511**



Parte empotrada lavabo de pared EMPOTRADO_ZA033511

MODELO **ZA033511**

Parte empotrada lavabo de pared, con montura de derecha y montura de izquierda

ACABADOS DISPONIBLES



CARACTERÍSTICAS

Empotrado **1**

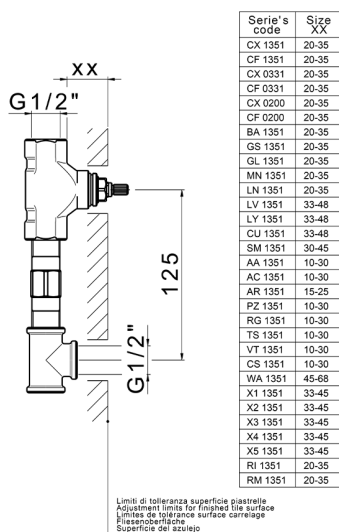

2026-06-15