

Grifo de un sólo agua de pared TR_TR001420

cisal

TR 00142 (TR 00144)

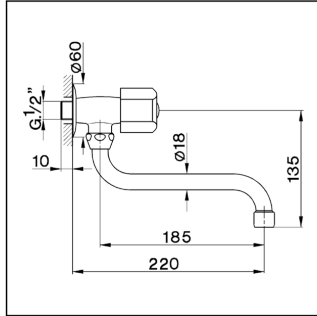

- Rubinetto a parete
- Simple tap
- Spültisch-Schwenkventil
- Robinet de service

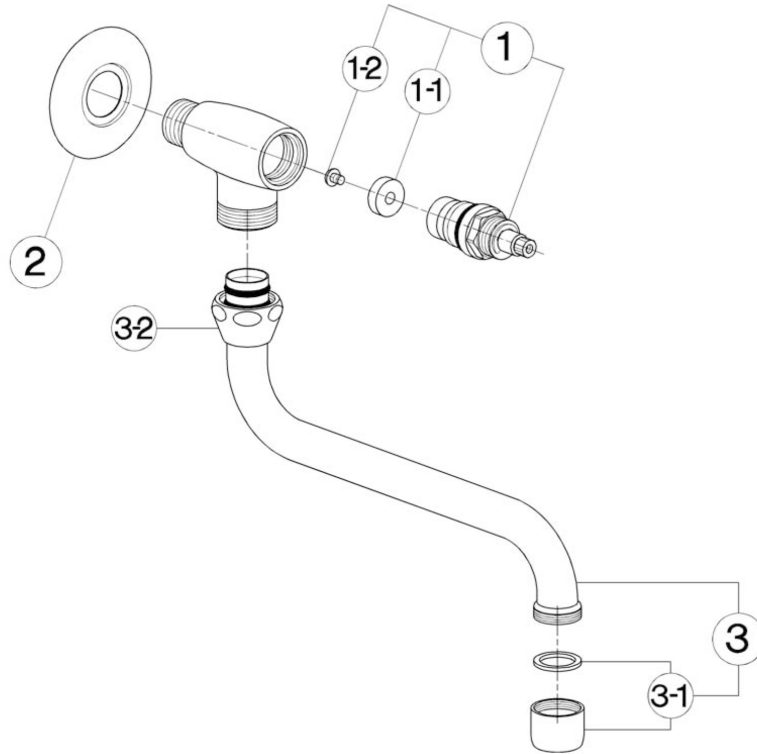

bar	PORTATA BOCCA DI EROGAZIONE * SPOUT FLOW RATE DURCHFLOSS WÄNNENEINLAUF DEBIT BEC DÉVERSEUR l/min.
0.1	14.5
0.2	20
0.3	25
0.4	28.5
0.5	31.5
1	44

* con rompigetto
with antispash
mit Strahlregler
avec brise-jet

NR.	DESCRIZIONE DESCRIPTION BESCHREIBUNG DESCRIPTION	N. CODICE CODE NO. WERKSNR. NR. CODE	NR.	DESCRIZIONE DESCRIPTION BESCHREIBUNG DESCRIPTION	N. CODICE CODE NO. WERKSNR. NR. CODE	NR.	DESCRIZIONE DESCRIPTION BESCHREIBUNG DESCRIPTION	N. CODICE CODE NO. WERKSNR. NR. CODE
1	Vitone 1/2" "TR" Headvalve 1/2" "TR" Oberteil 1/2" "TR" Tête 1/2" "TR"	ZZ 92869 0	3-2	Calotta 3/4" es.29 Ø19.5 Nur 3/4" Ø19.5 Mutter 3/4" Ø19.5 Ecrrou 3/4" Ø19.5	ZZ 92615 0			
1-1	Guarnizione NBR 90 SH. 16.9x5.5x5 Gasket NBR 90 SH. 16.9x5.5x5 Dichtung NBR 90 SH. 16.9x5.5x5 Joint NBR 90 SH. 16.9x5.5x5	ZZ 92699 0						
1-2	Vite M.4x4.5 tb. Ø8 l.cr. Screw M.4x4.5 Schraube M.4x4.5 Vis M.4x4.5	ZZ 92625 0						
2	Rosone rubinetto rovesciato Escutcheon simple tap Rosette Rosace en inox	ZZ 92605 0						
3	Canna a S Ø18 interasse 185 Swinging spout 185 Ø18 Auslauf-Rohr-S-185 Ø18 Bec orientable 185 Ø18	ZZ 92735 0						
3-1	Rompigetto M.22x1 Antispash M.22x1 Strahlregler M.22x1 Brise-jet M.22x1	ZZ 92771 0						

TR001420

<https://es.cisal.it/grifo-de-un-solo-agua-de-pared-tr-tr001420>

2026-06-15