

Parte externa monomando de suelo NUOVA LESS_LN014510

LN014510

<https://es.cisal.it/parte-externa-monomando-de-suelo-nuova-less-ln014510>

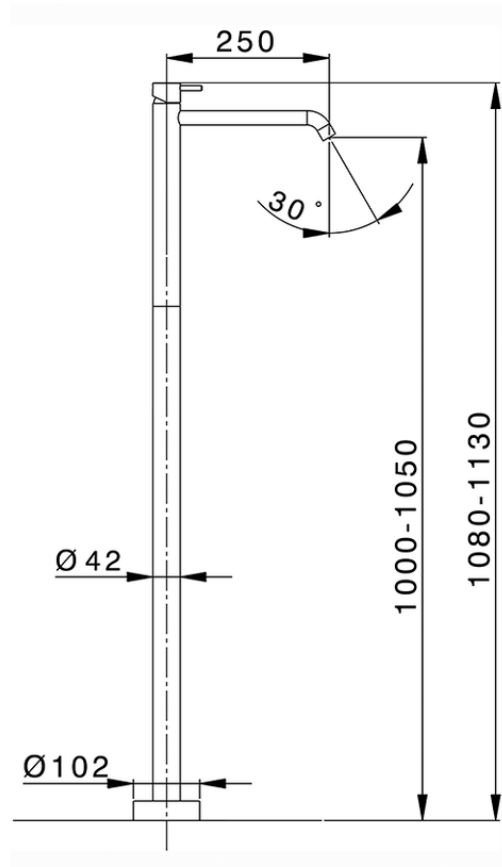

ZA004510

<https://es.cisal.it/parte-empotrada-monomando-free-standing-empotrado-za004510>

2026-04-29