





## Bañera termostática LINEAVIVA\_LVT21010

MODELO **LVT21010**

Bañera termostática, sin conjunto ducha, conexión para flexible 1/2" M

### ACABADOS DISPONIBLES

-  **21** 21 Cromo
-  **2B** 2B Níquel Brillo
-  **2F** 2F Níquel Cepillado
-  **40** 40 Negro Mate
-  **4Q** 4Q Blanco Mate

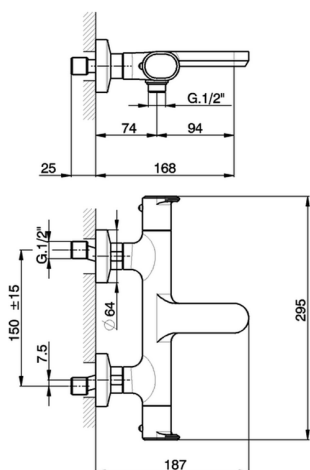

### CARACTERÍSTICAS

Recambio Cartucho **ZZ96551000**

**Cartucho Termostático TMX 25**



#### DeviaStop

La tecnología Cisal DeviaStop le permite ajustar el caudal de agua y dirigirla hacia la salida elegida (rociador superior, ducha de mano, etc.).



#### SafeTouch

El sistema Cisal SafeTouch mantiene el cuerpo de la grifería frío al cuerpo durante el uso.



#### Termostático

El termostático Cisal es tu gestor personal del agua, ayudándote a manejar, controlar y ahorrar agua y energía.



## Bañera termostática LINEAVIVA\_LVT21010

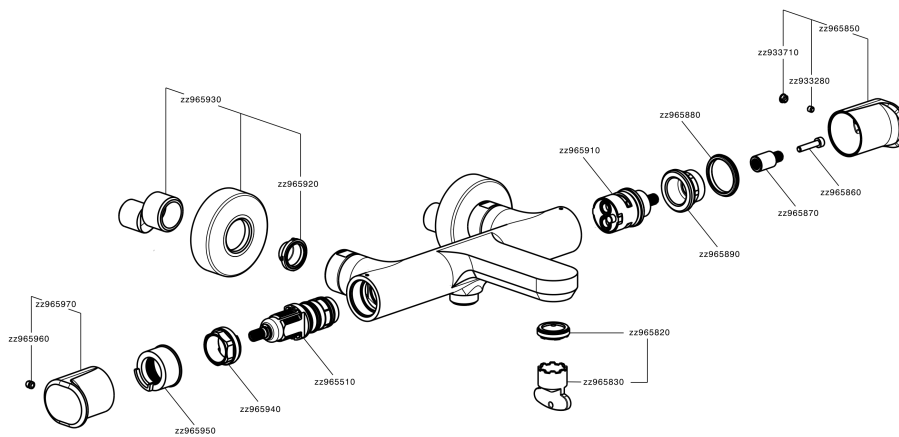

LVT21010

<https://es.cisal.it/banera-termostatica-lineaviva-lvt21010>

2024-11-23