

## Maneta M TR\_TM010080

# cisal

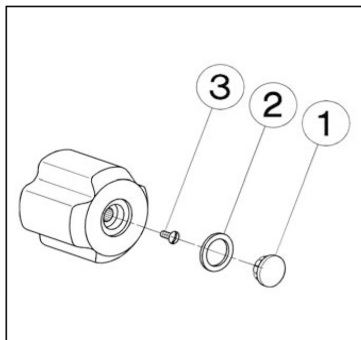

### TM 01001

- Maniglia "F"
- Handle "F"

NR.	DESCRIZIONE DESCRIPTION BESCHREIBUNG DESCRIPTION	N. CODICE CODE NO. WERKSNR. NR. CODE
1	Placchetta a scatto per maniglia "F" - "P" Cap for handle "F" - "P" Abdeckkappe 1/Griff "F" - "P" Plaque cache - vis crois. "F" - "P"	ZZ 92608 0
2	Anello rosso per maniglia "F" - "P" Red ring for handle "F" - "P" Ring - rot - 1/Griff "F" - "P" Anneau rouge - croisillon "F" - "P"	ZZ 92684 0
2	Anello blu per maniglia "F" - "P" Blue ring for handle "F" - "P" Ring - blau - 1/Griff "F" - "P" Anneau bleu - croisillon "F" - "P"	ZZ 92698 0
3	Vite M.4,5x10 tb. tc. zigrinata Screw M.4,5x10 Schraube M.4,5x10 Vis M.4,5x10	ZZ 92609 0

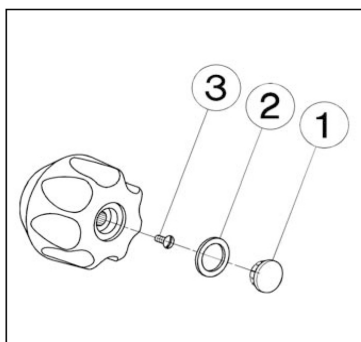

### TM 01002

- Maniglia "P"
- Handle "P"

NR.	DESCRIZIONE DESCRIPTION BESCHREIBUNG DESCRIPTION	N. CODICE CODE NO. WERKSNR. NR. CODE
1	Placchetta a scatto per maniglia "F" - "P" Cap for handle "F" - "P" Abdeckkappe 1/Griff "F" - "P" Plaque cache - vis crois. "F" - "P"	ZZ 92608 0
2	Anello rosso per maniglia "F" - "P" Red ring for handle "F" - "P" Ring - rot - 1/Griff "F" - "P" Anneau rouge - croisillon "F" - "P"	ZZ 92684 0
2	Anello blu per maniglia "F" - "P" Blue ring for handle "F" - "P" Ring - blau - 1/Griff "F" - "P" Anneau bleu - croisillon "F" - "P"	ZZ 92698 0
3	Vite M.4,5x10 tb. tc. zigrinata Screw M.4,5x10 Schraube M.4,5x10 Vis M.4,5x10	ZZ 92609 0

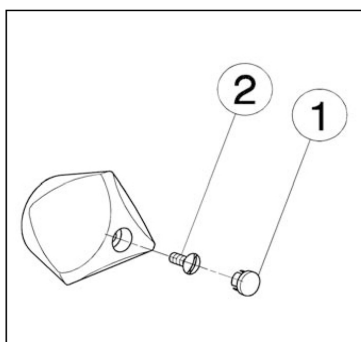

### TM 01008

- Maniglia "M"
- Handle "M"

NR.	DESCRIZIONE DESCRIPTION BESCHREIBUNG DESCRIPTION	N. CODICE CODE NO. WERKSNR. NR. CODE
1	Placchetta Ø13 blu per maniglia "M" Cap Ø13 for handle "M" - blue Abdeckkappe Ø13 blau 1/Griff "M" Plaque cache - vis bleue crois. "M"	ZZ 92706 0
1	Placchetta Ø13 rossa per maniglia "M" Cap Ø13 for handle "M" - red Abdeckkappe Ø13 rot 1/Griff "M" Plaque cache - vis rouge crois. "M"	ZZ 92707 0
2	Vite M.4,5x10 tb. tc. zigrinata Screw M.4,5x10 Schraube M.4,5x10 Vis M.4,5x10	ZZ 92609 0

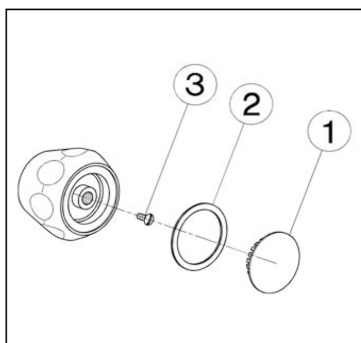

### TM 01010

- Maniglia "D"
- Handle "D"

NR.	DESCRIZIONE DESCRIPTION BESCHREIBUNG DESCRIPTION	N. CODICE CODE NO. WERKSNR. NR. CODE
1	Placchetta Ø36 per maniglia "D" Cap for handle "D" Abdeckkappe 1/Griff "D" Plaque cache - vis crois. "D"	ZZ 92647 0
2	Anello blu per maniglia "D" Blue ring for handle "D" Ring - blau - 1/Griff "D" Anneau bleu - croisillon "D"	ZZ 92712 0
2	Anello rosso per maniglia "D" Red ring for handle "D" Ring - rot - 1/Griff "D" Anneau rouge - croisillon "D"	ZZ 92713 0
3	Vite M.4,5x10 tb. tc. zigrinata Screw M.4,5x10 Schraube M.4,5x10 Vis M.4,5x10	ZZ 92609 0

TM010080

<https://es.cisal.it/maneta-m-tr-tm010080>

2024-11-21