

Parte externa termostático ducha 3 funciones WELLNESS_X100R300

MODELO **X100R300**

Parte externa termostático ducha 3 funciones, para art.ZA00R300 instalación horizontal, para art.ZA00V300 instalación vertical, Inox AISI 316L

ACABADOS DISPONIBLES

-  **5H** 5H Dark Brass Brushed
-  **5L** 5L Brushed Black Titanium
-  **5N** 5N Oro Rosa Cepillado
-  **D1** D1 Inox Cepillado

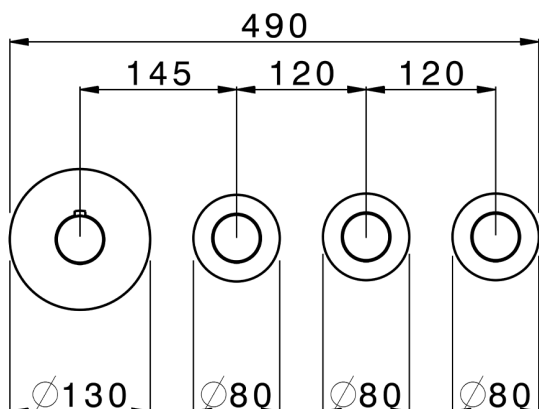
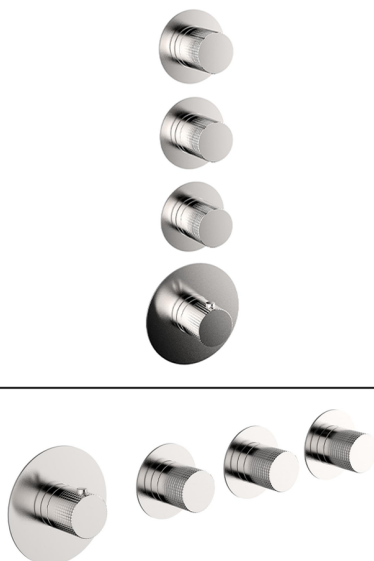

CARACTERÍSTICAS

Instalación	Empotrado
Empotrado 2	ZA00V300
	ZA00R300



Termostático

El termostático Cisal es tu gestor personal del agua, ayudándote a manejar, controlar y ahorrar agua y energía.



Parte externa termostático ducha 3 funciones WELLNESS_X100R300

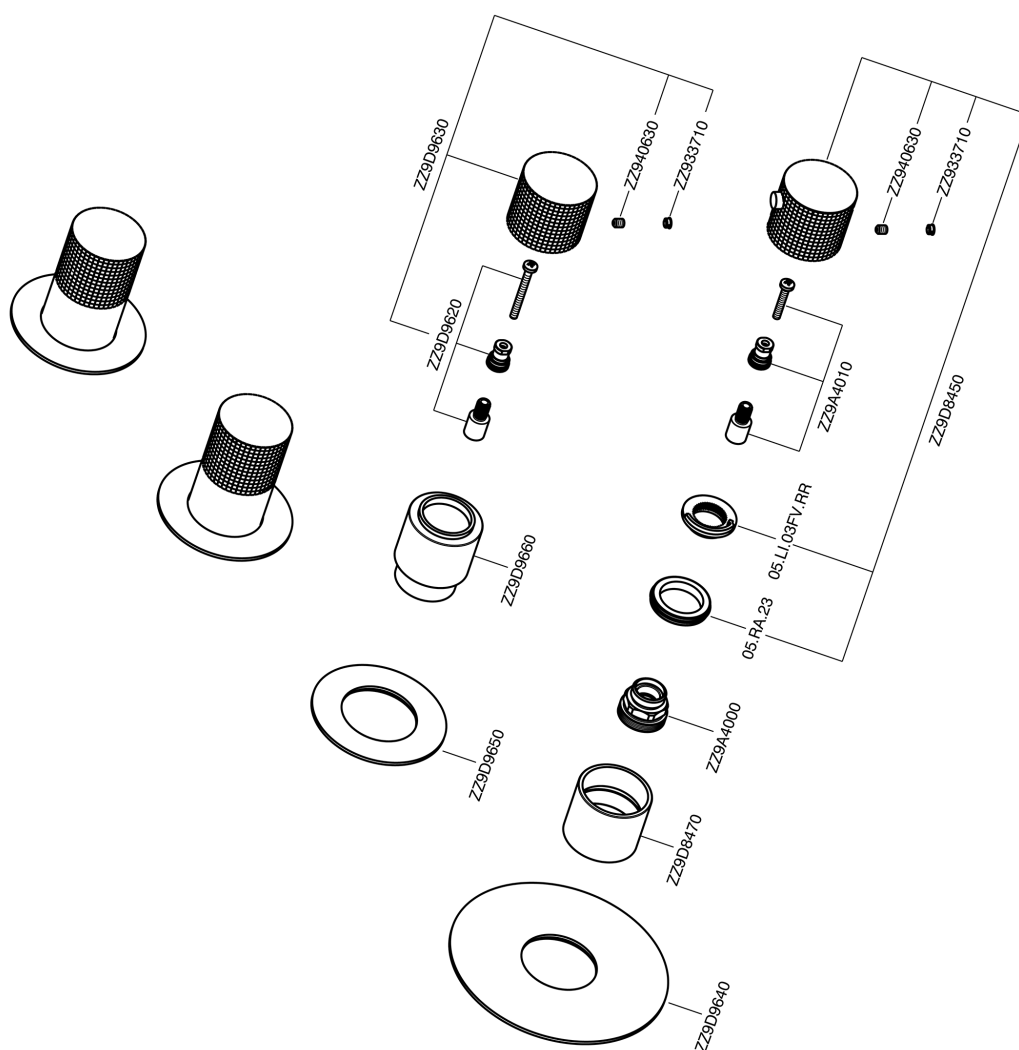

X100R300

<https://es.cisal.it/parte-externa-termostatico-ducha-3-funciones-wellnessx100r300>

Parte empotrada termostático 3 funciones EMPOTRADO_ZA00V300

MODELO **ZA00V300**

Parte empotrada termostático 3 funciones

ACABADOS DISPONIBLES



CARACTERÍSTICAS

Recambio Cartucho **23.51A.HF**

Empotrado **1**

Cartucho Termostático HF

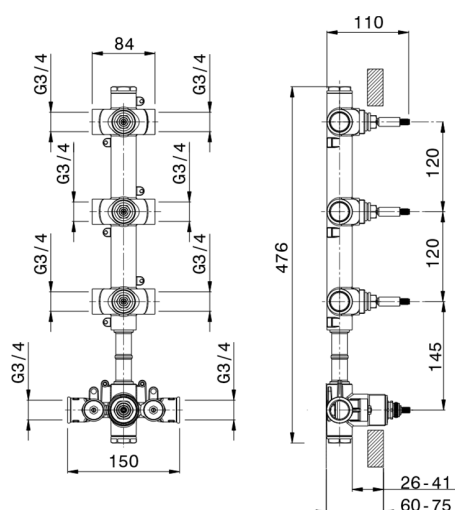

Termostático

El termostático Cisal es tu gestor personal del agua, ayudándote a manejar, controlar y ahorrar agua y energía.



Parte empotrada termostático 3 funciones EMPOTRADO_ZA00R300

MODELO **ZA00R300**

Parte empotrada termostático 3 funciones

ACABADOS DISPONIBLES

 **04** 04 Sin acabado

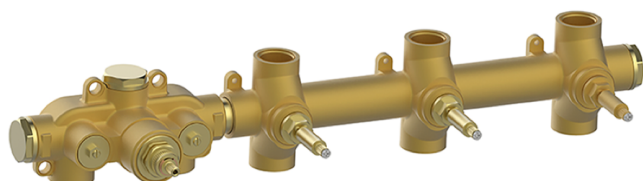

CARACTERÍSTICAS

Recambio Cartucho **23.51A.HF**

Empotrado **1**

Cartucho Termostático HF

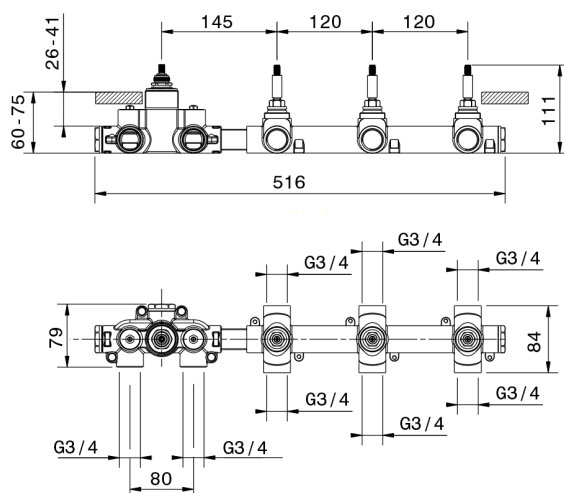

Termostático

El termostático Cisal es tu gestor personal del agua, ayudándote a manejar, controlar y ahorrar agua y energía.



2024-09-19