

Parte externa monomando baño/ducha empotrado CHERIE_CH002100



MODELO **CH002100**

Parte externa monomando baño/ducha empotrado, desviador automático 2 salidas, sin parte empotrada, para art. ZA004210 - ZA004213

ACABADOS DISPONIBLES

- 
6T 6T Cromo/Negro Mate
- 
7C 7C Oro/Negro Mate
- 
7D 7D Niquel Brillo/Negro Mate
- 
7E 7E Oro Rosa/Negro Mate

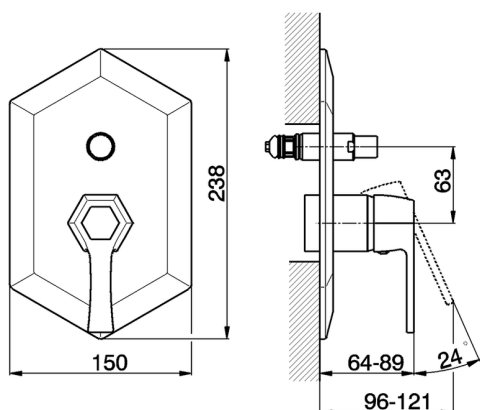

CARACTERÍSTICAS

Instalación	Empotrado
Empotrado 2	ZA004213
	ZA004210



Parte externa monomando baño/ducha empotrado CHERIE_CH002100

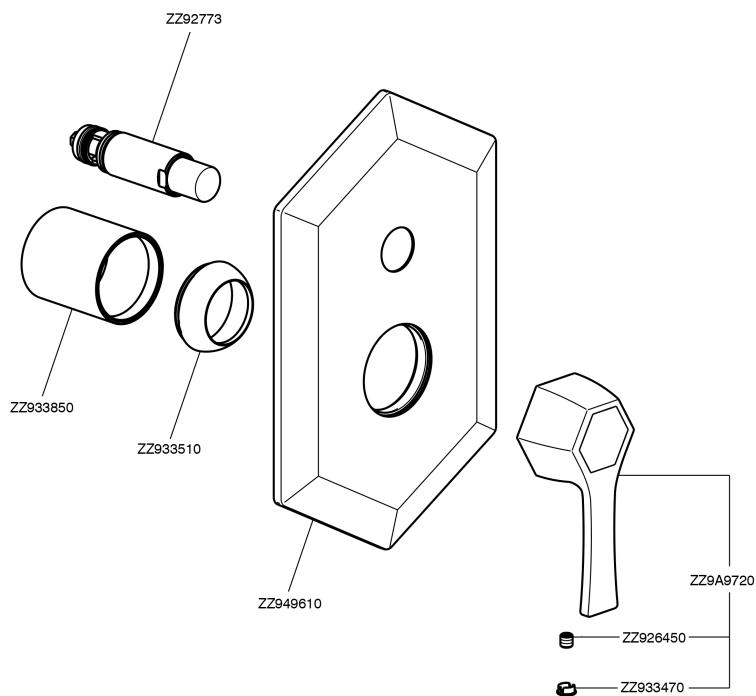

CH002100

<https://es.cisal.it/parte-externa-monomando-bano-ducha-empotrado-cherie-ch002100>

Parte empotrada monomando baño/ducha EMPOTRADO_ZA004210

MODELO **ZA004210**

Parte empotrada monomando baño/ducha, desviador automático, con silenciadores, sin parte externa

ACABADOS DISPONIBLES



04 04 Sin acabado



CARACTERÍSTICAS

Recambio Cartucho **ZZ93196000**

Empotrado **1**

Cartucho Monomando 38 mm

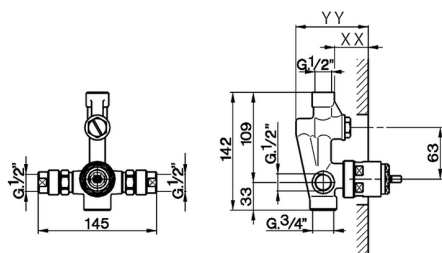

Piastra/Plate/Plaque/Platte/Placa

2-3mm: XX 25-55 YY 72-102

10mm: XX 15-40 YY 62-87



2026-04-30