

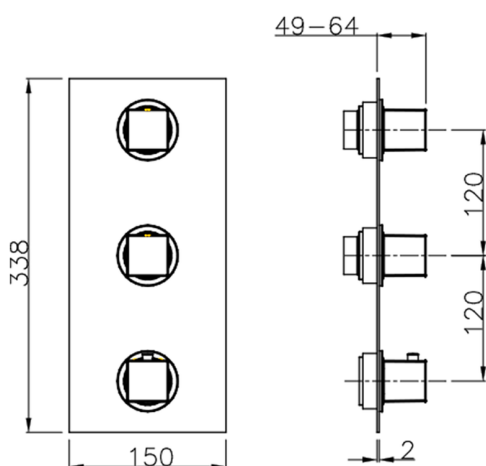





Parte externa termostático ducha 2 funciones WELLNESS_RA01V200



MODELO **RA01V200**

Parte externa termostático ducha 2 funciones, para art.ZA01V200

ACABADOS DISPONIBLES

-  **21** 21 Cromo
-  **2B** 2B Niquel Brillo
-  **2F** 2F Niquel Cepillado
-  **2Q** 2Q Black Titanium
-  **40** 40 Negro Mate
-  **4Q** 4Q Blanco Mate

CARACTERÍSTICAS

Instalación	Empotrado
Empotrado 1	ZA01V200



Termostático

El termostático Cisal es tu gestor personal del agua, ayudándote a manejar, controlar y ahorrar agua y energía.



Parte empotrada termostático ducha 2 funciones EMPOTRADO_ZA01V200

MODELO **ZA01V200**

Parte empotrada termostático ducha 2 funciones

ACABADOS DISPONIBLES

 **04** 04 Sin acabado

CARACTERÍSTICAS

Recambio Cartucho **23.51A.HF**

Empotrado **1**

Cartucho Termostático HF

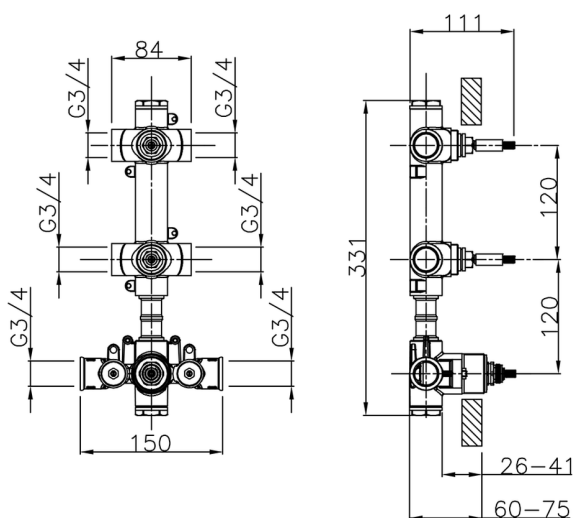

Termostático

El termostático Cisal es tu gestor personal del agua, ayudándote a manejar, controlar y ahorrar agua y energía.



2026-04-30