

Parte externa lavabo de pared HI-RISE_RI013511

MODELO **RI013511**

Parte externa lavabo de pared, sin parte empotrada, para art. ZA033510

ACABADOS DISPONIBLES

-  **21** 21 Cromo
-  **6X** 6X Blanco Mate/Oro Cepillado
-  **6V** 6V Blanco Mate/Niquel Cepillado
-  **5G** 5G Oro Rosa
-  **4Q** 4Q Blanco Mate
-  **40** 40 Negro Mate
-  **2W** 2W Oro Cepillado
-  **2F** 2F Niquel Cepillado
-  **24** 24 Oro
-  **7W** 7W Negro Mate/Oro Cepillado

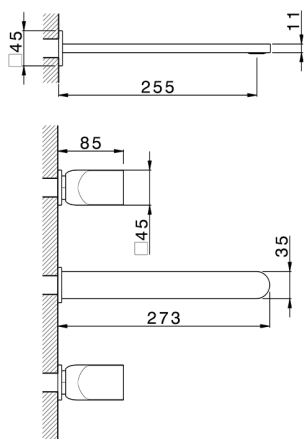
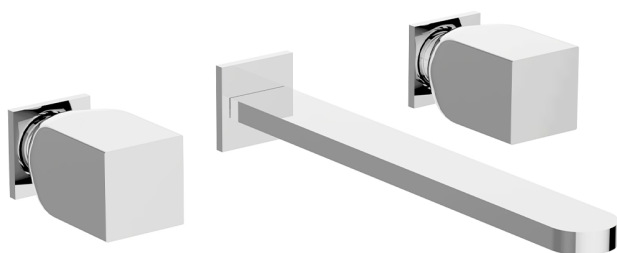

CARACTERÍSTICAS

Instalación
Empotrado 1

Empotrado
ZA033510



Parte empotrada lavabo de pared EMPOTRADO_ZA033510

MODELO **ZA033510**

Parte empotrada lavabo de pared, con dos monturas de apertura hacia la derecha

ACABADOS DISPONIBLES

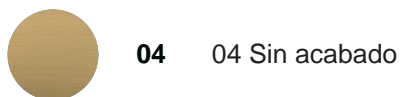

CARACTERÍSTICAS

Empotrado **1**

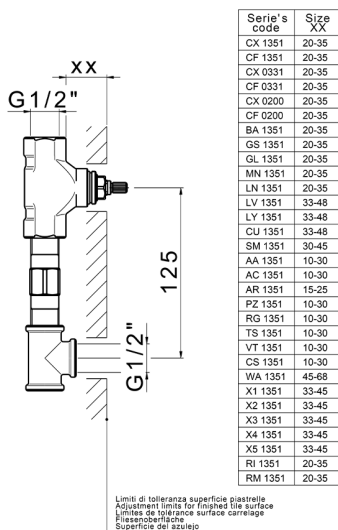

2024-11-21