

Parte externa termostático ducha 3 funciones WELLNESS_GS00R300

MODELO **GS00R300**

Parte externa termostático ducha 3 funciones, para art.ZA00R300 instalación horizontal, para art.ZA00V300 instalación vertical



ACABADOS DISPONIBLES

-  **21** 21 Cromo
-  **2F** 2F Niquel Cepillado
-  **2W** 2W Oro Cepillado
-  **5H** 5H Dark Brass Brushed
-  **5L** 5L Brushed Black Titanium
-  **6T** 6T Cromo/Negro Mate

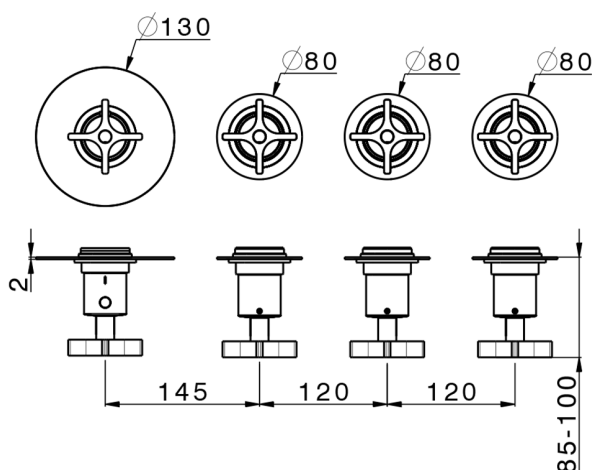

CARACTERÍSTICAS

Instalación **Empotrado**
 Empotrado 2 **ZA00V300**
ZA00R300



Termostático

El termostático Cisal es tu gestor personal del agua, ayudándote a manejar, controlar y ahorrar agua y energía.



Parte empotrada termostático 3 funciones EMPOTRADO_ZA00V300

MODELO **ZA00V300**

Parte empotrada termostático 3 funciones

ACABADOS DISPONIBLES



CARACTERÍSTICAS

Recambio Cartucho **23.51A.HF**

Empotrado **1**

Cartucho Termostático HF

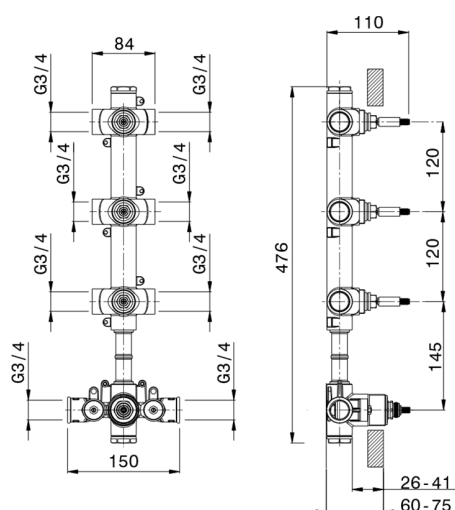

Termostático

El termostático Cisal es tu gestor personal del agua, ayudándote a manejar, controlar y ahorrar agua y energía.



Parte empotrada termostático 3 funciones EMPOTRADO_ZA00R300

MODELO **ZA00R300**

Parte empotrada termostático 3 funciones

ACABADOS DISPONIBLES

 **04** 04 Sin acabado

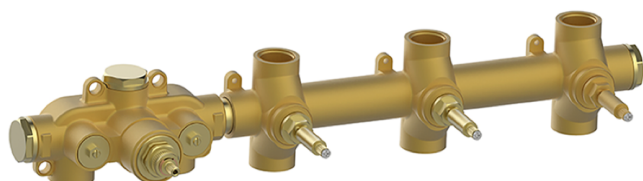

CARACTERÍSTICAS

Recambio Cartucho **23.51A.HF**

Empotrado **1**

Cartucho Termostático HF

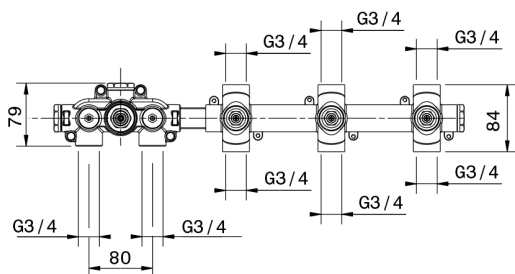
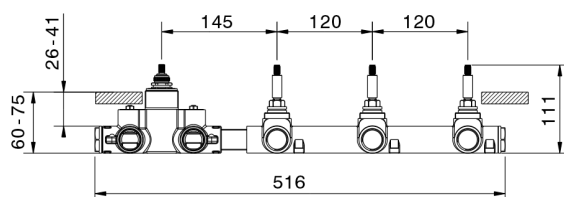

Termostático

El termostático Cisal es tu gestor personal del agua, ayudándote a manejar, controlar y ahorrar agua y energía.



2025-01-15