

Parte externa termostático ducha empotrada ROADSTER ACCENT_RA007200

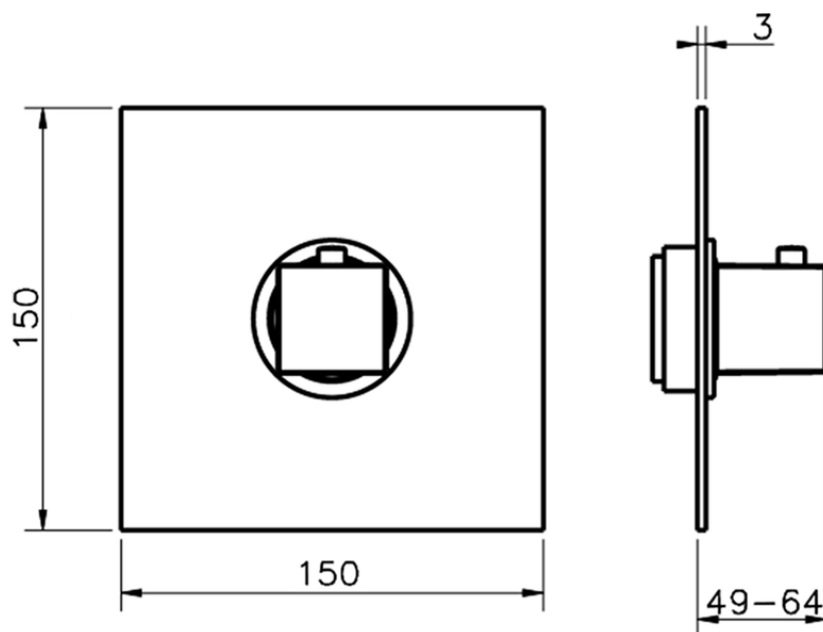

RA007200

<https://es.cisal.it/parte-externa-termostatico-ducha-empotrada-roadster-accent-ra007200>

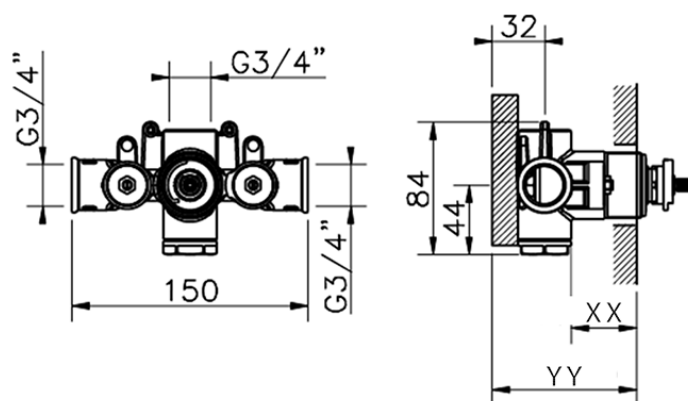

Piastra/Plate/Plaque/Platte/Placa

2-3mm: XX 25-40 YY 76-91

10mm: XX 16-31 YY 65-80

ZA007220

<https://es.cisal.it/parte-empotrada-termostatico-3-4-empotrado-za007220>

2026-05-03