

## Parte externa monomando baño/ducha empotrado ARCANA EMPRESS\_EM002100

MODELO **EM002100**

Parte externa monomando baño/ducha empotrado,desviador automático 2 salidas,sin parte empotrada,para art.ZA002210



### ACABADOS DISPONIBLES

-  **21** 21 Cromo
-  **24** 24 Oro
-  **26** 26 Cobre Viejo
-  **27** 27 Bronce Viejo
-  **2A** 2A Niquel Satinado Cepillado
-  **74** 74 Cromo/Oro

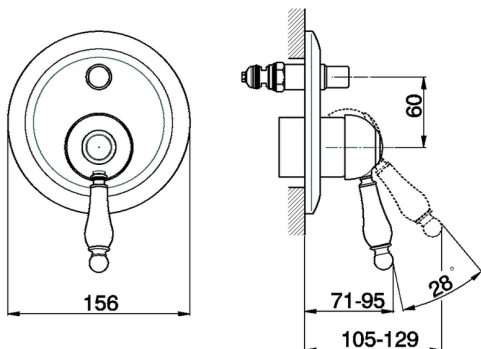

### CARACTERÍSTICAS

Instalación	<b>Empotrado</b>
Empotrado 1	<b>ZA002210</b>



## Parte externa monomando baño/ducha empotrado ARCANA EMPRESS\_EM002100

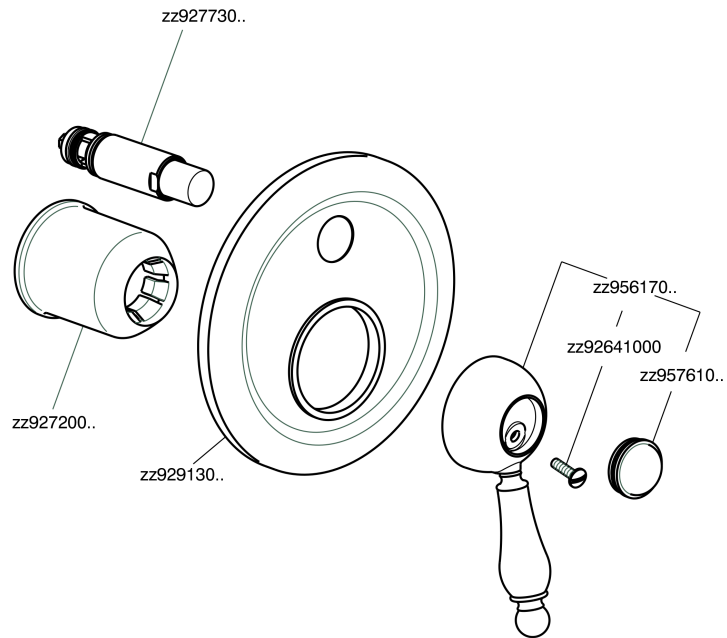

EM002100

<https://es.cisal.it/parte-externa-monomando-bano-ducha-empotrado-arcana-empress-em002100>

## Parte empotrada monomando baño/ducha EMPOTRADO\_ZA002210

MODELO **ZA002210**

Parte empotrada monomando baño/ducha, desviador  
2 salidas 1/2" y 3/4", sin parte externa

ACABADOS DISPONIBLES



**04** 04 Sin acabado



CARACTERÍSTICAS

Recambio Cartucho **ZZ92909000**

Empotrado **1**

**Cartucho Monomando 43 mm**

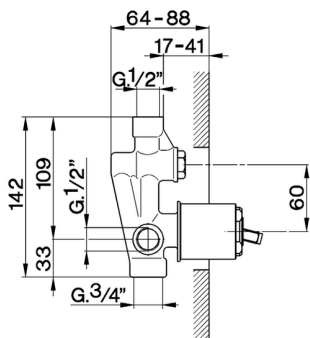

2026-05-02