

Grifo de un sólo agua TR_TR000740

cisal

TR 00074 (TR 00075)

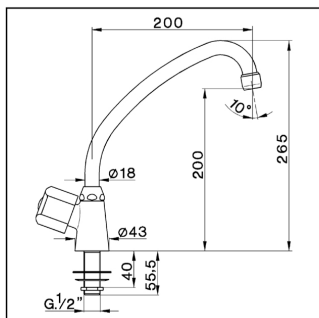

- Rubinetto a colonna
- Deck-mounted single tap
- Standschwenkventil
- Robinet de comptoir

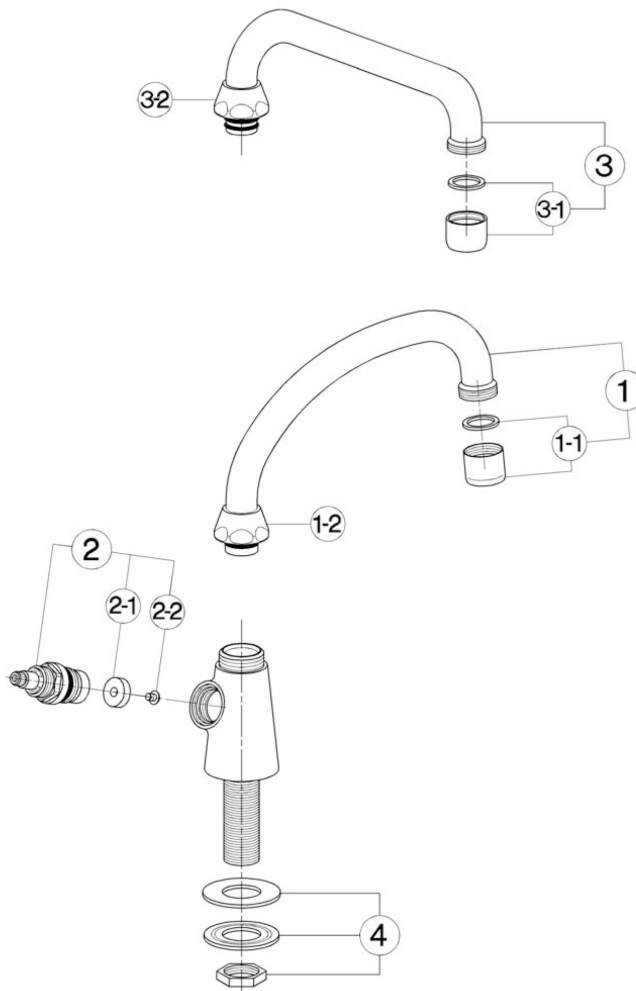

bar	PORTATA BOCCA DI EROGAZIONE * SPOUT FLOW RATE DURCHFLOSS WÄNNENEINLAUF DEBIT BEC DÉVERSEUR l/min.
0.1	10
0.2	14.5
0.3	18.5
0.4	21.5
0.5	24.5
1	34.5

* con rompigetto
with antispash
mit Strahlregler
avec brise-jet

NR.	DESCRIZIONE DESCRIPTION BESCHREIBUNG DESCRIPTION	N. CODICE CODE NO. WERKSNR. NR. CODE	NR.	DESCRIZIONE DESCRIPTION BESCHREIBUNG DESCRIPTION	N. CODICE CODE NO. WERKSNR. NR. CODE	NR.	DESCRIZIONE DESCRIPTION BESCHREIBUNG DESCRIPTION	N. CODICE CODE NO. WERKSNR. NR. CODE
1	Canna alla Ø18 interasse 200 Swinging spout 200 Ø18 Auslauf-Rohr-U-200 Ø18 Bec orientable 200 Ø18	ZZ 92739 0	3	Canna a U Ø185 interasse 185 Swinging spout 185 Ø185 Auslauf-Rohr-U-185 Ø185 Bec orientable 185 Ø185	ZZ 92736 0			
1-1	Rompigetto M.22x1 Antispash M.22x1 Strahlregler M.22x1 Brise-jet M.22x1	ZZ 92771 0	3-1	Rompigetto M.22x1 Antispash M.22x1 Strahlregler M.22x1 Brise-jet M.22x1	ZZ 92771 0			
1-2	Calotta 3/4" es.29 Ø19.5 Nut 3/4" Ø19.5 Mutter 3/4" Ø19.5 Eccrou 3/4" Ø19.5	ZZ 92615 0	3-2	Calotta 3/4" es.29 Ø19.5 Nut 3/4" Ø19.5 Mutter 3/4" Ø19.5 Eccrou 3/4" Ø19.5	ZZ 92615 0			
2	Vitone 1/2" "TR" Headvalve 1/2" "TR" Oberteil 1/2" "TR" Tête 1/2" "TR"	ZZ 92869 0	4	Set installazione rubinetto a colonna Installation set deck-mounted tap Befestigungsset Set installation	ZZ 92740 0			
2-1	Guarnizione NBR 90 SH. 16.9x5.5x5 Gasket NBR 90 SH. 16.9x5.5x5 Dichtung NBR 90 SH. 16.9x5.5x5 Joint NBR 90 SH. 16.9x5.5x5	ZZ 92699 0						
2-2	Vite M.4x4.5 tb. Ø8 l.cr. Screw M.4x4.5 Schraube M.4x4.5 Vis M.4x4.5	ZZ 92625 0						

TR000740

<https://es.cisal.it/grifo-de-un-solo-agua-tr-tr000740>

2024-12-22