

Ducha monomando empotrada XION_XI000304

MODELO **XI000304**

Ducha monomando empotrada,compreensivo de parte empotrada,Inox AISI 316L

ACABADOS DISPONIBLES



D1 D1 Inox Cepillado

CARACTERÍSTICAS

Recambio Cartucho **ZZ96779000**

Cartucho Monomando 35 mm

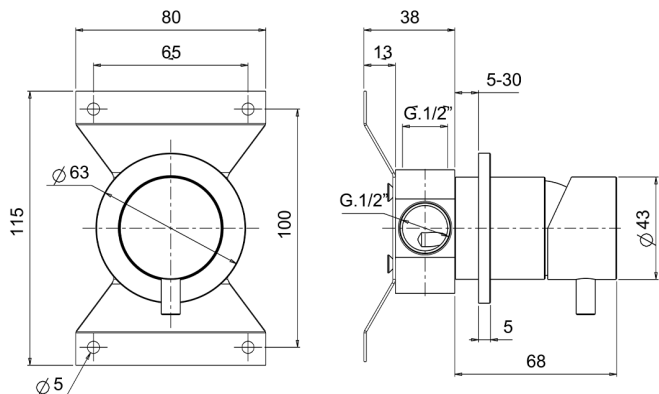

Ducha monomando empotrada XION_XI000304

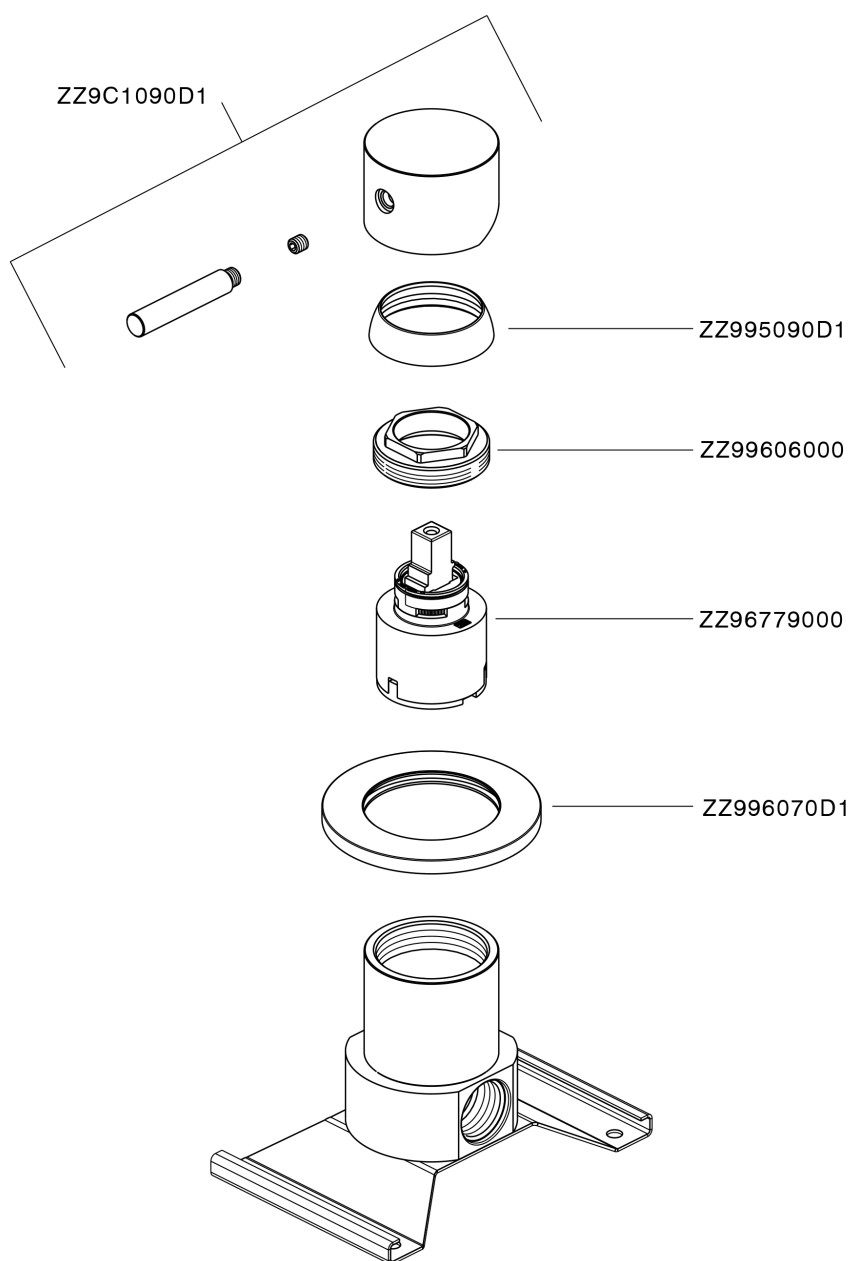

XI000304

<https://es.cisal.it/ducha-monomando-empotrada-xion-xi000304>

2026-05-01