

Parte externa termostático ducha emp. 3 salidas SMOOTH X32_X3018200

MODELO **X3018200**

Parte externa termostático ducha emp.3 salidas,con deviasstop 3 salidas,sin parte empotrada,para art.ZA018201,con manetas lisa - Inox AISI 316L

ACABADOS DISPONIBLES

-  **5H** 5H Dark Brass Brushed
-  **5L** 5L Brushed Black Titanium
-  **5N** 5N Oro Rosa Cepillado
-  **D1** D1 Inox Cepillado

CARACTERÍSTICAS

Instalación **Empotrado**
Empotrado 1 **ZA018201**

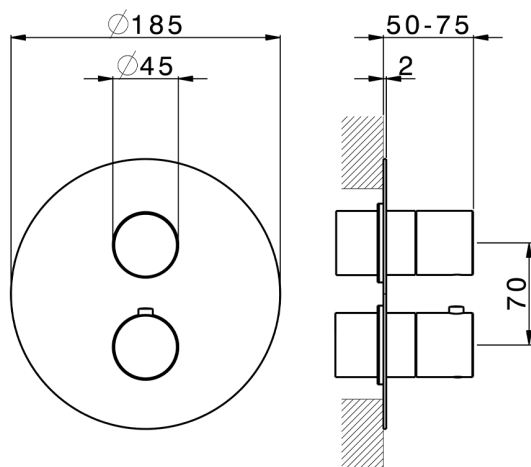
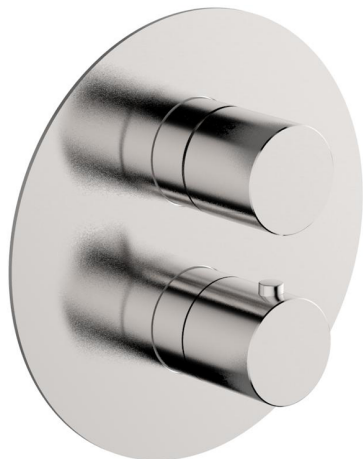

Termostático

El termostático Cisal es tu gestor personal del agua, ayudándote a manejar, controlar y ahorrar agua y energía.



Parte externa termostático ducha emp. 3 salidas SMOOTH X32_X3018200

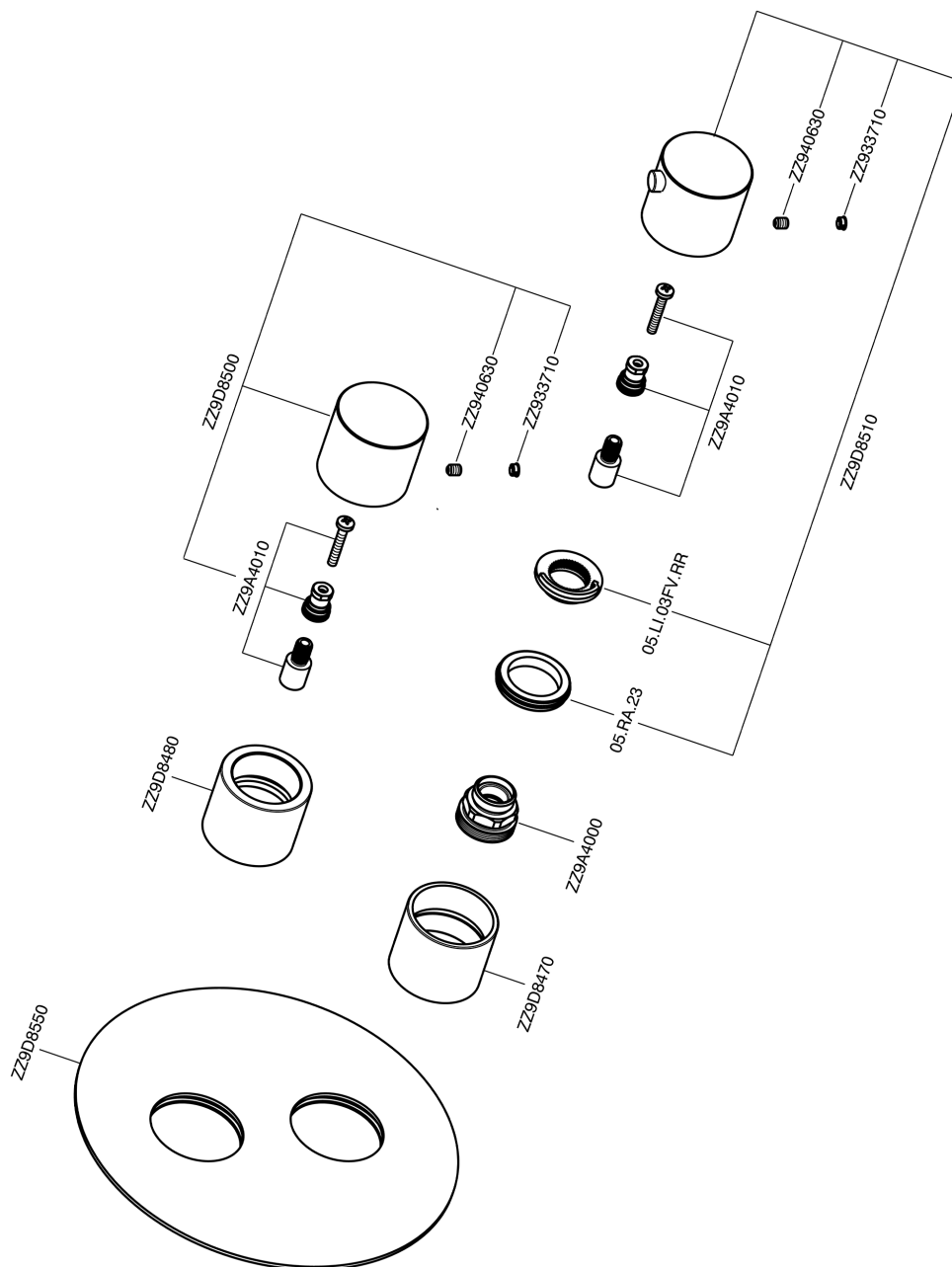

X3018200

<https://es.cisal.it/parte-externa-termostatico-ducha-emp-3-salidas-smooth-x32-x3018200>

Parte empotrada termostático ducha 3 salidas EMPOTRADO_ZA018201

MODELO **ZA018201**

Parte empotrada termostático ducha 3 salidas, con devia stop 3 salidas 1/2", sin parte externa



ACABADOS DISPONIBLES



04 04 Sin acabado

CARACTERÍSTICAS

Recambio Cartucho **24.04A.PP**

Empotrado **1**

Cartucho Termostático Plus P 8X20

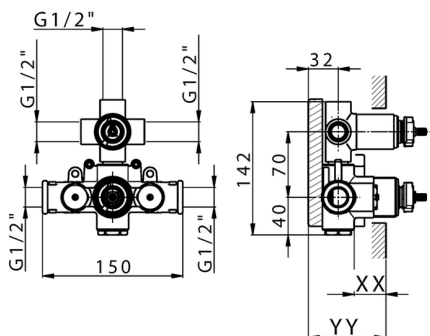

Piastra/Plate/Plaque/Platte/Placa

2-3mm: XX 25-40 YY 76-91

10 mm: XX 16-31 YY 65-80



DeviaStop

La tecnología Cisal DeviaStop le permite ajustar el caudal de agua y dirigirla hacia la salida elegida (rociador superior, ducha de mano, etc.).



Termostático

El termostático Cisal es tu gestor personal del agua, ayudándote a manejar, controlar y ahorrar agua y energía.



2024-12-22