

Parte externa monomando ducha empotrada HI-RISE_RI003000

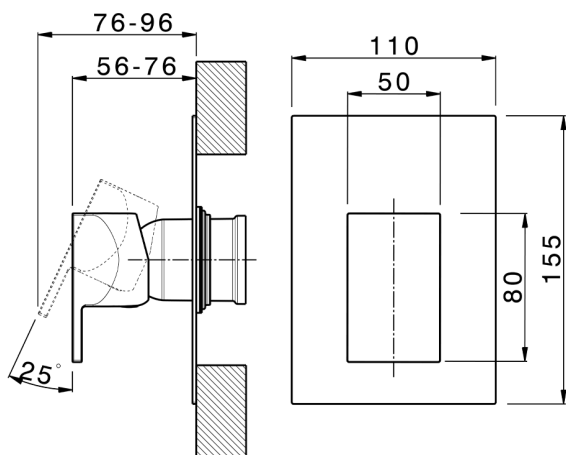
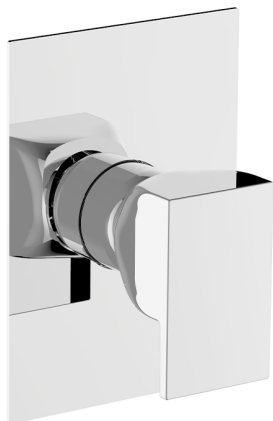

MODELO **RI003000**

Parte externa monomando ducha empotrada, sin parte empotrada, para art. ZA005300-ZA005301

ACABADOS DISPONIBLES

-  **21** 21 Cromo
-  **24** 24 Oro
-  **2F** 2F Niquel Cepillado
-  **2W** 2W Oro Cepillado
-  **40** 40 Negro Mate
-  **4Q** 4Q Blanco Mate
-  **5G** 5G Oro Rosa
-  **6V** 6V Blanco Mate/Niquel Cepillado
-  **6X** 6X Blanco Mate/Oro Cepillado
-  **7W** 7W Negro Mate/Oro Cepillado

CARACTERÍSTICAS

Instalación **Empotrado**
 Empotrado 2 **ZA005301**
ZA005300



Parte empotrada monomando ducha EMPOTRADO_ZA005301

MODELO **ZA005301**

Parte empotrada monomando ducha, ducha empotrada 1/2", sin parte externa, con silenciadores

ACABADOS DISPONIBLES



04 04 Sin acabado



CARACTERÍSTICAS

Recambio Cartucho **ZZ94035000**

Empotrado **1**

Cartucho Monomando 35 mm

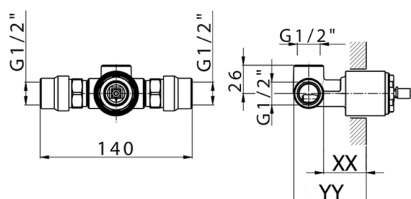

Piastra/Plate/Plaque/Platte/Placa

2-3mm: XX 27-47 YY 54-74

10mm: XX 16-40 YY 43-68



Parte empotrada monomando ducha EMPOTRADO_ZA005300



MODELO **ZA005300**

Parte empotrada monomando ducha, ducha empotrada 1/2", sin parte externa

ACABADOS DISPONIBLES



04 04 Sin acabado

CARACTERÍSTICAS

Recambio Cartucho **ZZ94035000**

Empotrado **1**

Cartucho Monomando 35 mm



Piastra/Plate/Plaque/Platte/Placa
 2-3mm: XX 27-47 YY 54-74
 10mm: XX 16-40 YY 43-68



2026-04-29