

## Parte empotrada termostático ducha 2 salidas EMPOTRADO\_ZA019140

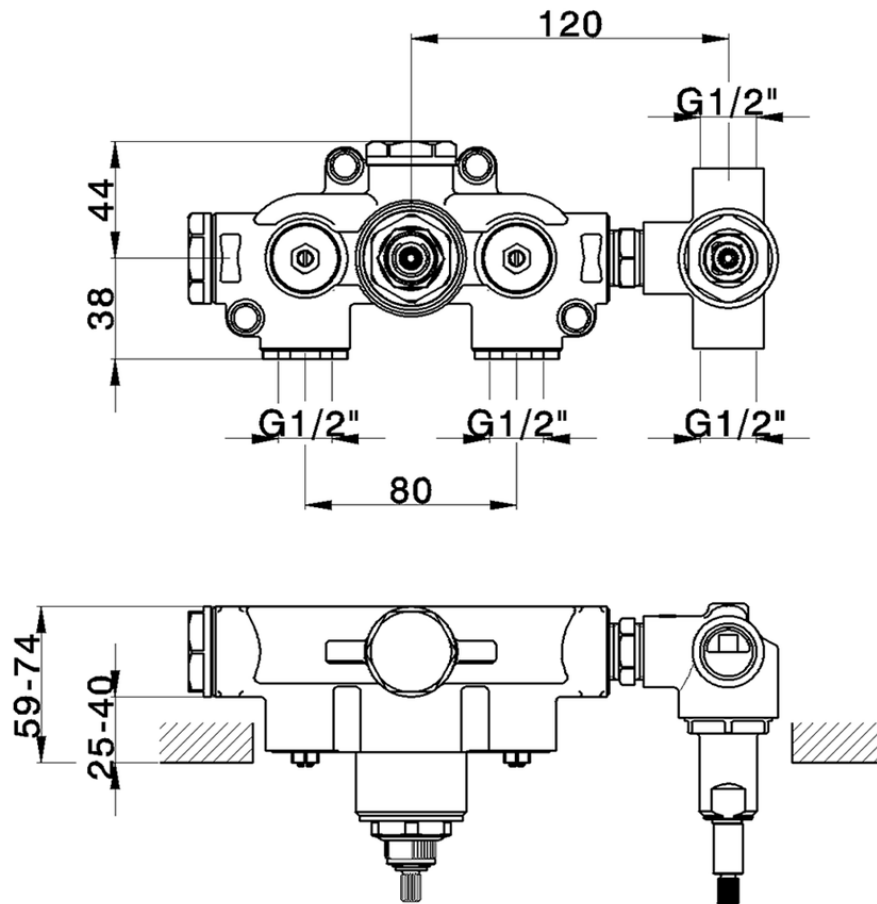

ZA019140

<https://es.cisal.it/parte-empotrada-termostatico-ducha-2-salidas-empotrado-za019140>

2026-04-29