





Bañera termostática con duplex VITA_VID21010

MODELO **VID21010**

Bañera termostática con duplex, soporte duchita mural, duchita una función Ø 23 mm de Latón, flexible lisse SUPREME 150 cm

ACABADOS DISPONIBLES

-  **21** 21 Cromo
-  **2Q** 2Q Black Titanium
-  **40** 40 Negro Mate
-  **4Q** 4Q Blanco Mate

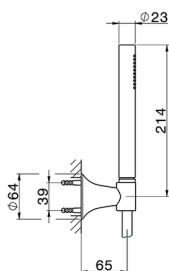
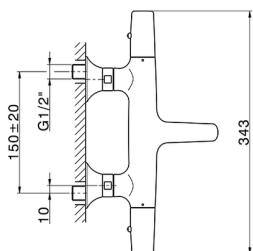
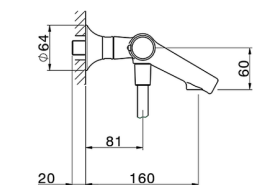

CARACTERÍSTICAS

Recambio Cartucho **ZZ96551000**

Cartucho Termostático TMX 25



DeviaStop

La tecnología Cisal DeviaStop le permite ajustar el caudal de agua y dirigirla hacia la salida elegida (rociador superior, ducha de mano, etc.).



SafeTouch

El sistema Cisal SafeTouch mantiene el cuerpo de la grifería frío al cuerpo durante el uso.



Termostático

El termostático Cisal es tu gestor personal del agua, ayudándote a manejar, controlar y ahorrar agua y energía.



Bañera termostática con duplex VITA_VID21010

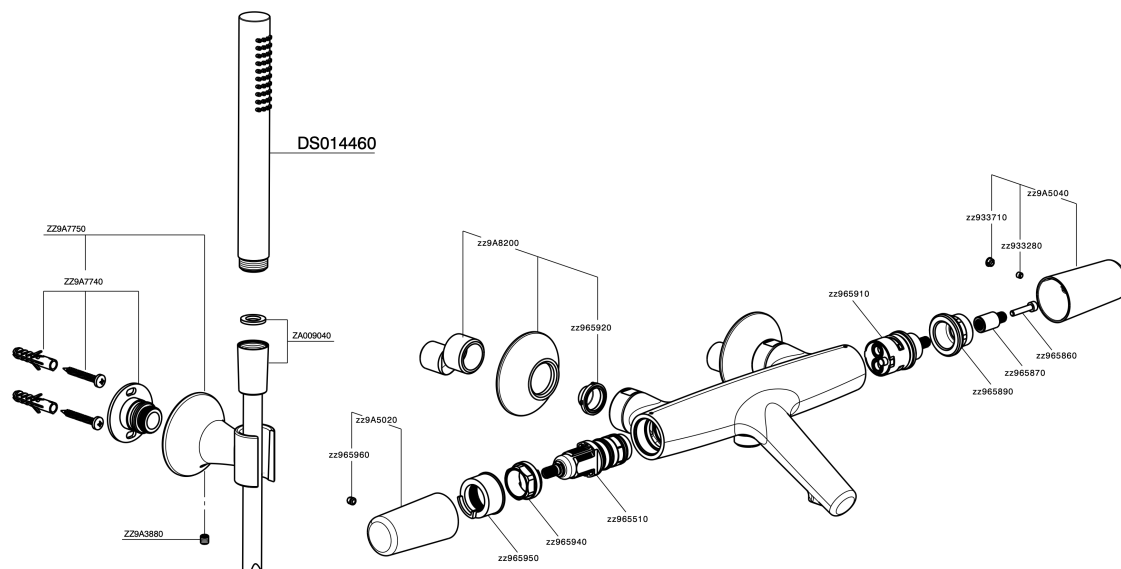

VID21010

<https://es.cisal.it/banera-termostatica-con-duplex-vita-vid21010>

2025-01-15