

Parte externa monomando ducha empotrada SMOOTH X32_X3003000

X3003000

<https://es.cisal.it/parte-externa-monomando-ducha-empotrada-smooth-x32-x3003000>

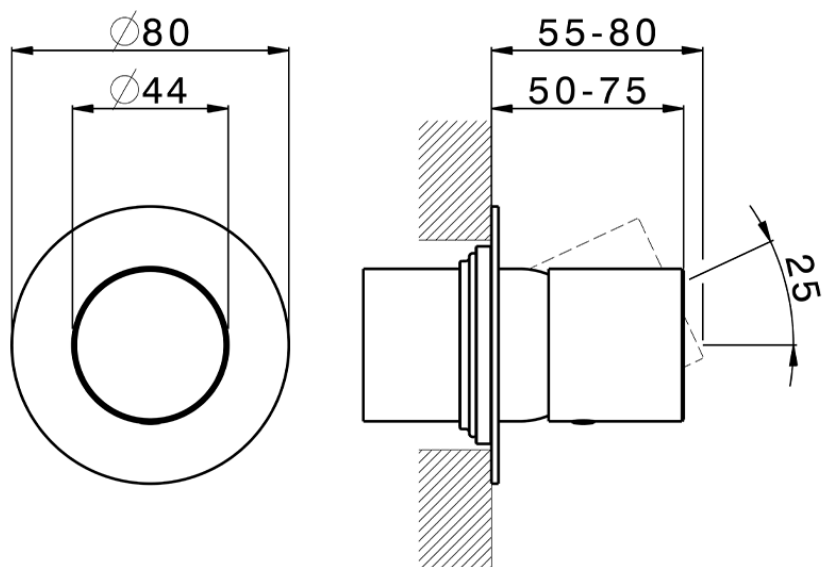

Piastra/Plate/Plaque/Platte/Placa

2-3mm: XX 27-47 YY 54-74

10mm: XX 16-40 YY 43-68

ZA005301

<https://es.cisal.it/parte-empotrada-monomando-ducha-empotrado-za005301>



Piastra/Plate/Plaque/Platte/Placa

2-3mm: XX 27-47 YY 54-74

10mm: XX 16-40 YY 43-68

ZA005300

<https://es.cisal.it/parte-empotrada-monomando-ducha-empotrado-za005300>

2026-06-20