

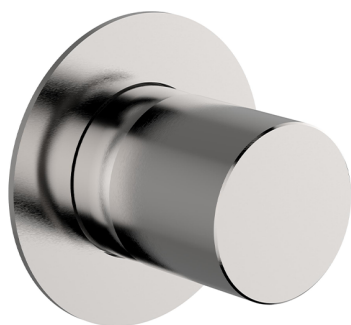

Parte externa monomando ducha empotrada SMOOTH X32_X3003000

MODELO **X3003000**

Parte externa monomando ducha empotrada, sin parte empotrada, para art. ZA005300-ZA005301, con maneta lisa, Inox AISI 316L



ACABADOS DISPONIBLES

-  **D1** D1 Inox Cepillado
-  **5H** 5H Dark Brass Brushed
-  **5L** 5L Brushed Black Titanium
-  **5N** 5N Oro Rosa Cepillado

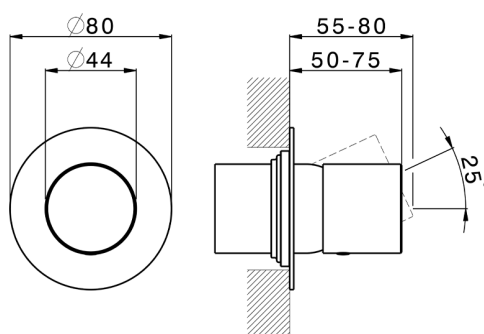

CARACTERÍSTICAS

Instalación **Empotrado**
 Empotrado 2 **ZA005301**
ZA005300



Parte esterna monomando ducha empotrada SMOOTH X32_X3003000

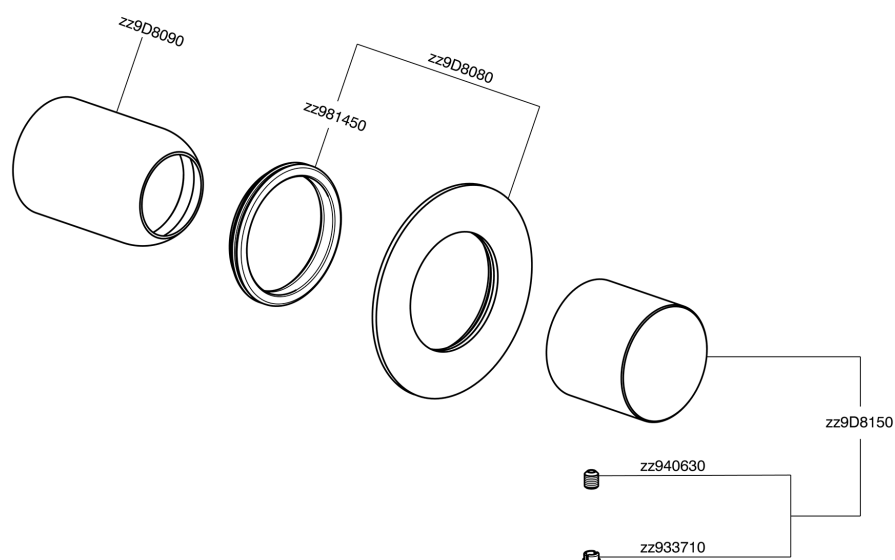

X3003000

<https://es.cisal.it/parte-externa-monomando-ducha-empotrada-smooth-x32-x3003000>

Parte empotrada monomando ducha EMPOTRADO_ZA005301

MODELO **ZA005301**

Parte empotrada monomando ducha, ducha empotrada 1/2", sin parte externa, con silenciadores

ACABADOS DISPONIBLES



04 04 Sin acabado



CARACTERÍSTICAS

Recambio Cartucho **ZZ94035000**

Empotrado **1**

Cartucho Monomando 35 mm



Piastra/Plate/Plaque/Platte/Placa
 2-3mm: XX 27-47 YY 54-74
 10mm: XX 16-40 YY 43-68



Parte empotrada monomando ducha EMPOTRADO_ZA005300



MODELO **ZA005300**

Parte empotrada monomando ducha, ducha empotrada 1/2", sin parte externa

ACABADOS DISPONIBLES



04 04 Sin acabado

CARACTERÍSTICAS

Recambio Cartucho **ZZ94035000**

Empotrado **1**

Cartucho Monomando 35 mm



Piastra/Plate/Plaque/Platte/Placa
 2-3mm: XX 27-47 YY 54-74
 10mm: XX 16-40 YY 43-68



2026-06-20