

Toallero de pie ARCANA COMPLEMENTOS _AR090950

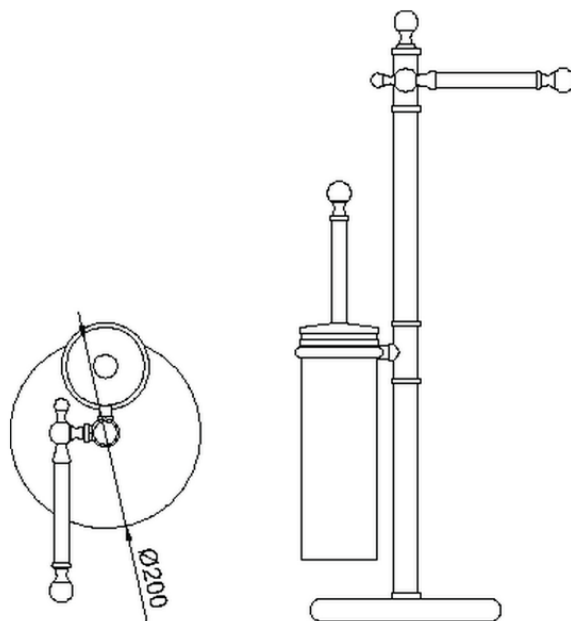

AR090950

<https://es.cisal.it/toallero-de-pie-arcana-complementos-ar090950>

2026-06-14