







Toallero de pie ARCANA COMPLEMENTOS _AR090950

MODELO **AR090950**

Toallero de pie, con portarollos y escobillero



ACABADOS DISPONIBLES

-  **21** 21 Cromo
-  **24** 24 Oro
-  **26** 26 Cobre Viejo
-  **27** 27 Bronce Viejo
-  **2A** 2A Niquel Satinado Cepillado
-  **74** 74 Cromo/Oro

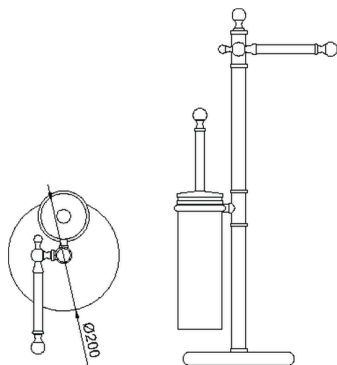

CARACTERÍSTICAS



2026-04-30