

Parte externa termostático ducha empotrada WAVE_WE007200



MODELO **WE007200**

Parte externa termostático ducha empotrada, sin llave de paso, sin parte empotrada, para art. ZA007221

ACABADOS DISPONIBLES

-  **21** 21 Cromo
-  **2F** 2F Niquel Cepillado
-  **2Q** 2Q Black Titanium

CARACTERÍSTICAS

Instalación	Empotrado
Empotrado 1	ZA007221

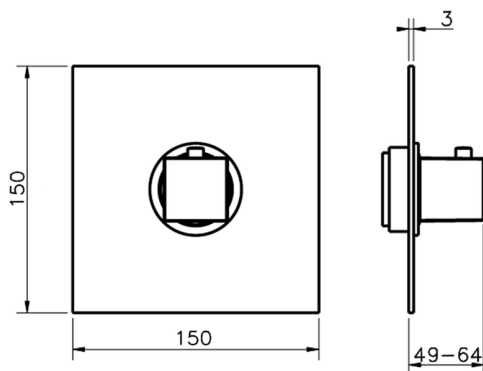

Termostático

El termostático Cisal es tu gestor personal del agua, ayudándote a manejar, controlar y ahorrar agua y energía.



Parte empotrada termostático 3/4" EMPOTRADO_ZA007221

MODELO **ZA007221**

Parte empotrada termostático 3/4", sin llave de paso, sin parte externa

ACABADOS DISPONIBLES

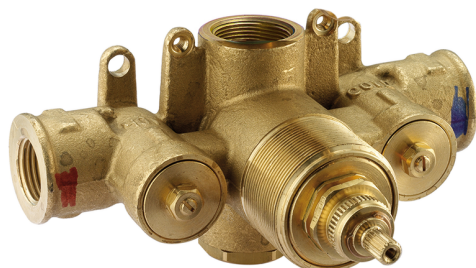

CARACTERÍSTICAS

Recambio Cartucho **23.51A.HF**

Empotrado **1**

Cartucho Termostático HF

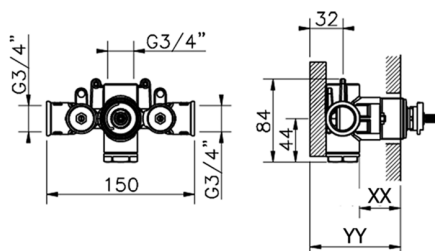

Piastra/Plate/Plaque/Platte/Placa
 2-3mm: XX 25-40 YY 76-91
 10mm: XX 16-31 YY 65-80



Termostático

El termostático Cisal es tu gestor personal del agua, ayudándote a manejar, controlar y ahorrar agua y energía.



2024-11-23