







## Parte externa termostático ducha 3 funciones ROADSTER ACCENT\_RA01R300

MODELO **RA01R300**

Parte externa termostático ducha 3 funciones, para art.ZA01R300

### ACABADOS DISPONIBLES

-  **21** 21 Cromo
-  **2B** 2B Niquel Brillo
-  **2F** 2F Niquel Cepillado
-  **2Q** 2Q Black Titanium
-  **40** 40 Negro Mate
-  **4Q** 4Q Blanco Mate

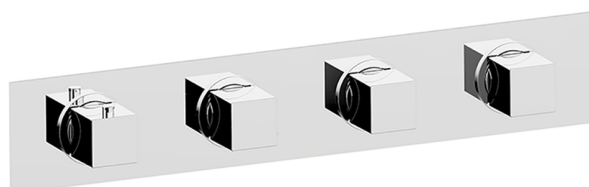

### CARACTERÍSTICAS

Instalación	<b>Empotrado</b>
Empotrado 1	<b>ZA01R300</b>



### Termostático

El termostático Cisal es tu gestor personal del agua, ayudándote a manejar, controlar y ahorrar agua y energía.



## Parte empotrada termostático 3 funciones EMPOTRADO\_ZA01R300

MODELO **ZA01R300**

Parte empotrada termostático 3 funciones

ACABADOS DISPONIBLES

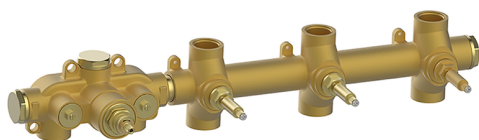

CARACTERÍSTICAS

Recambio Cartucho **23.51A.HF**

Empotrado **1**

**Cartucho Termostático HF**

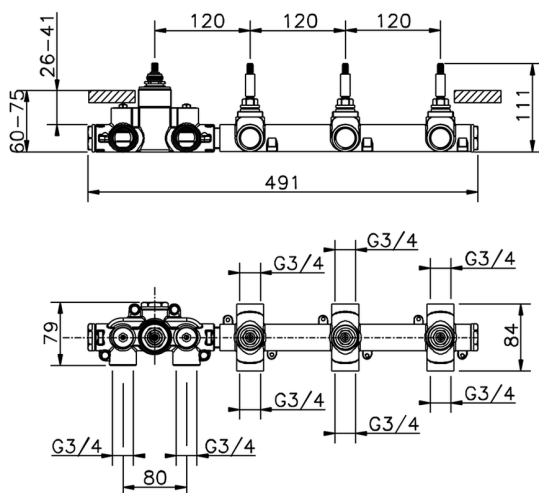

### Termostático

El termostático Cisal es tu gestor personal del agua, ayudándote a manejar, controlar y ahorrar agua y energía.



2026-06-19