





Fregadero monomando abatible ARCANA EMPRESS_EM001530

MODELO **EM001530**

Fregadero monomando abatible, caño giratorio, latiguillos acero G.3/8"



ACABADOS DISPONIBLES

-  **21** 21 Cromo
-  **24** 24 Oro
-  **26** 26 Cobre Viejo
-  **27** 27 Bronce Viejo
-  **2A** 2A Niquel Satinado Cepillado
-  **74** 74 Cromo/Oro

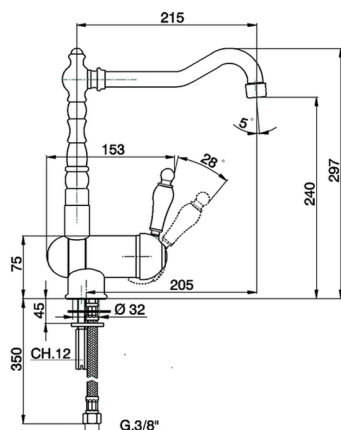

CARACTERÍSTICAS

Recambio Cartucho **ZZ92909000**

Cartucho Monomando 43 mm



Fregadero monomando abatible ARCANA EMPRESS_EM001530

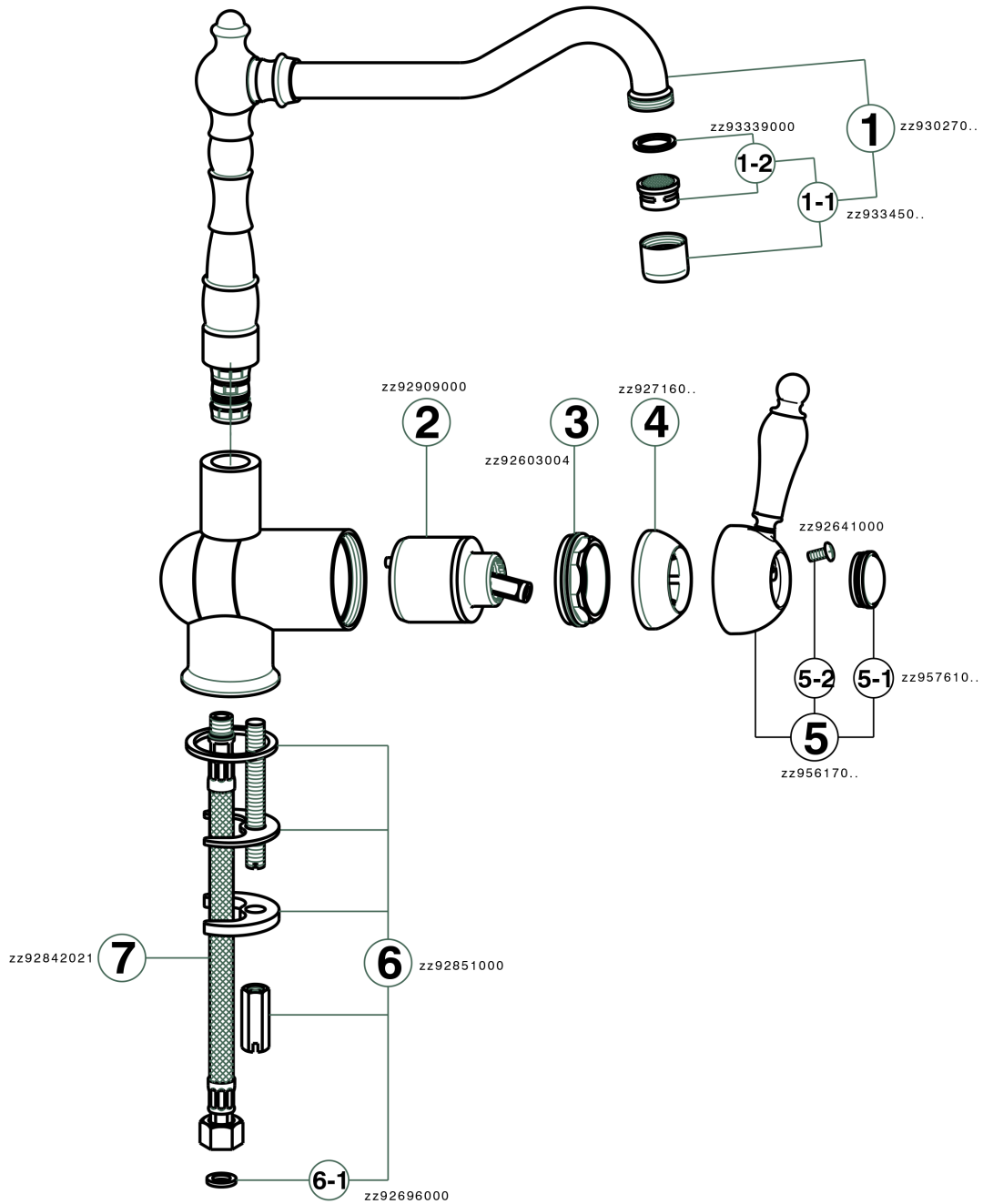

EM001530

<https://es.cisal.it/fregadero-monomando-abatible-arcana-empress-em001530>

2026-06-16