

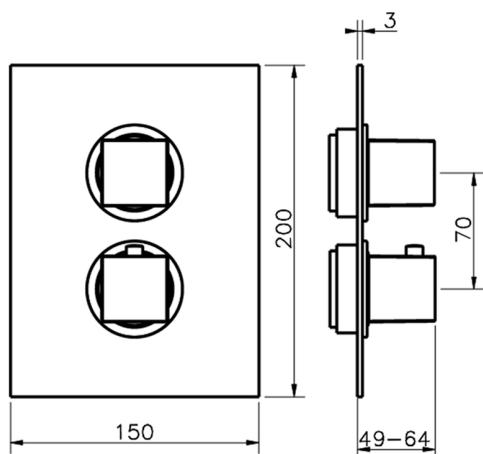





Parte externa termostático ducha emp. 1 salida ROADSTER ACCENT_RA007300



MODELO **RA007300**

Parte externa termostático ducha emp.1 salida,llave de paso,sin parte empotrada,para art.ZA007301-ZA007361

ACABADOS DISPONIBLES

-  **21** 21 Cromo
-  **2B** 2B Niquel Brillo
-  **2F** 2F Niquel Cepillado
-  **2Q** 2Q Black Titanium
-  **40** 40 Negro Mate
-  **4Q** 4Q Blanco Mate

CARACTERÍSTICAS

Instalación	Empotrado
Empotrado 1	ZA007301



Termostático

El termostático Cisal es tu gestor personal del agua, ayudándote a manejar, controlar y ahorrar agua y energía.



Parte empotrada termostático ducha 1 salida EMPOTRADO_ZA007301

MODELO **ZA007301**

Parte empotrada termostático ducha 1 salida, llave de paso con salida 1/2", sin parte externa

ACABADOS DISPONIBLES



04 04 Sin acabado



CARACTERÍSTICAS

Recambio Cartucho **24.04A.PP**

Empotrado **1**

Cartucho Termostático Plus P 8X20

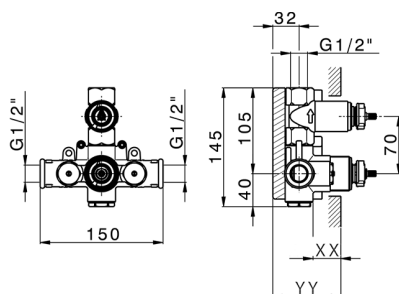

Piastra/Plate/Plaque/Platte/Placa

2-3mm: XX 25-40 YY 76-91

10mm: XX 16-31 YY 65-80



Termostático

El termostático Cisal es tu gestor personal del agua, ayudándote a manejar, controlar y ahorrar agua y energía.



2024-11-21