

Toallero de apoyo ARCANA COMPLEMENTOS _AR090910

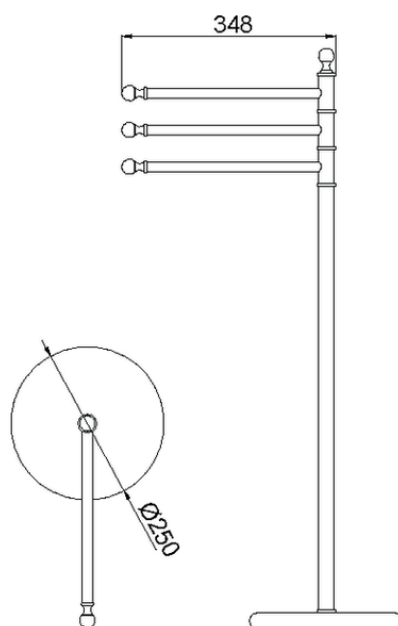

AR090910

<https://es.cisal.it/toallero-de-apoyo-arcana-complementos-ar090910>

2026-04-29