





## Parte externa llave de paso NUOVA LESS\_LN003310

MODELO **LN003310**

Parte externa llave de paso, sin parte empotrada, para art. ZA003330-ZA003340



### ACABADOS DISPONIBLES

-  **21** 21 Cromo
-  **2F** 2F Niquel Cepillado
-  **40** 40 Negro Mate
-  **4Q** 4Q Blanco Mate

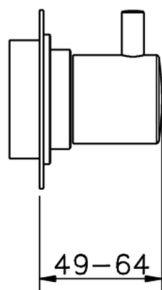
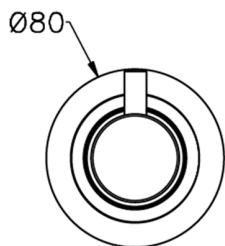

### CARACTERÍSTICAS

Instalación	<b>Empotrado</b>
Empotrado 2	<b>ZA003340</b>
	<b>ZA003330</b>



## Parte empotrada llave de paso 1/2" EMPOTRADO\_ZA003340

MODELO **ZA003340**

Parte empotrada llave de paso 1/2", apert. sentido contrario agujas del reloj

ACABADOS DISPONIBLES



**04** 04 Sin acabado

CARACTERÍSTICAS

Empotrado **1**

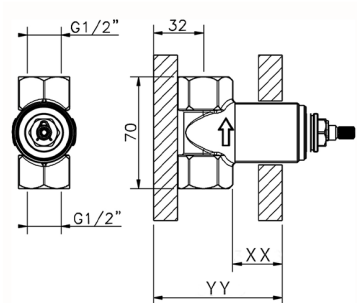

Piastra/Plate/Plaque/Platte/Placa  
 2-3mm: XX 31-46 YY 80-95  
 10mm: XX 25-40 YY 76-91



## Parte empotrada llave de paso 3/4" EMPOTRADO\_ZA003330

MODELO **ZA003330**

Parte empotrada llave de paso 3/4", apert. sentido contrario agujas del reloj



ACABADOS DISPONIBLES



**04** 04 Sin acabado

CARACTERÍSTICAS

Empotrado **1**

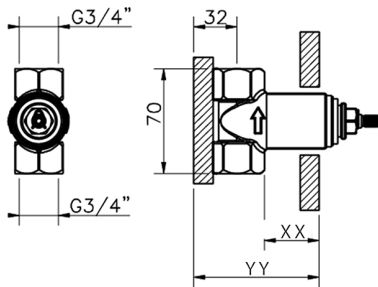

Piastra/Plate/Plaque/Platte/Placa

2-3mm: XX 31-46 YY 80-95

10mm: XX 25-40 YY 76-91



2026-04-30