

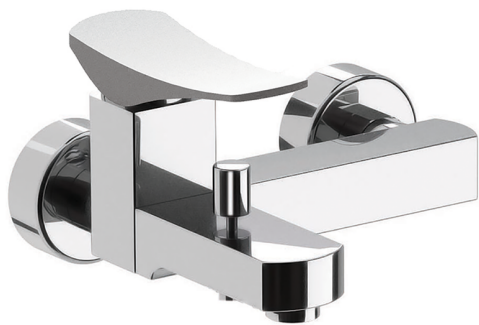





Bañera monomando ROADSTER ACCENT_RA000130

MODELO **RA000130**

Bañera monomando, sin conjunto ducha, conexión para flexible 1/2" M



ACABADOS DISPONIBLES

-  **21** 21 Cromo
-  **2B** 2B Niquel Brillo
-  **2F** 2F Niquel Cepillado
-  **2Q** 2Q Black Titanium
-  **40** 40 Negro Mate
-  **4Q** 4Q Blanco Mate

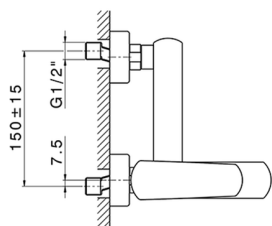
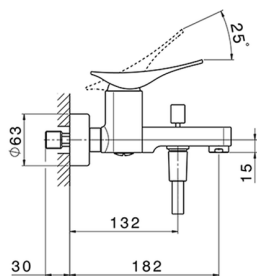

CARACTERÍSTICAS

Recambio Cartucho **ZZ96799000**

Cartucho Monomando 35 mm



Bañera monomando ROADSTER ACCENT_RA000130

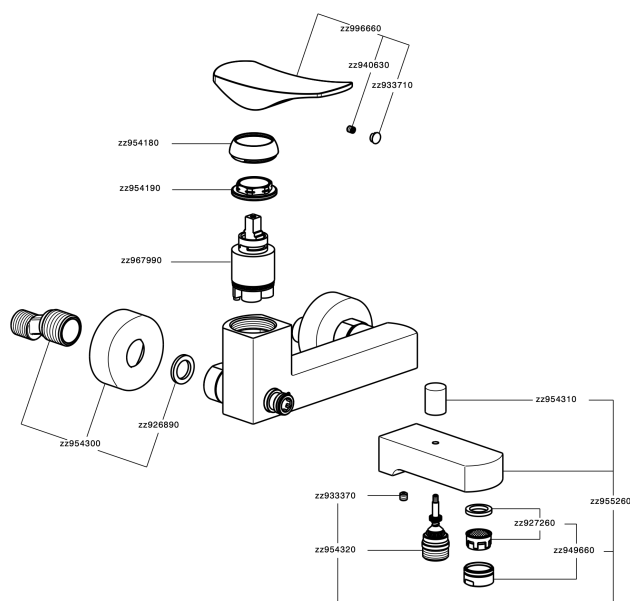

RA000130

<https://es.cisal.it/banera-monomando-roadster-accent-ra000130>

2025-01-15