

## Parte externa monomando baño/ducha empotrado ARCANA ROYAL\_AY002100

MODELO **AY002100**

Parte externa monomando baño/ducha empotrado, desviador automático 2 salidas, sin parte empotrada, para art. ZA002210



### ACABADOS DISPONIBLES

-  **21** 21 Cromo
-  **24** 24 Oro
-  **26** 26 Cobre Viejo
-  **27** 27 Bronce Viejo
-  **2A** 2A Niquel Satinado Cepillado
-  **74** 74 Cromo/Oro

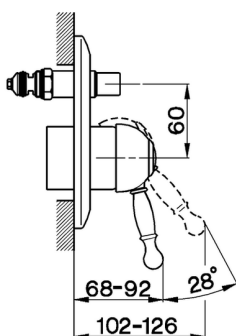
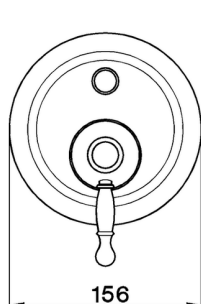

### CARACTERÍSTICAS

Instalación	<b>Empotrado</b>
Empotrado 1	<b>ZA002210</b>



## Parte esterna monomando baño/ducha empotrado ARCANA ROYAL\_AY002100

**cisal**

### AY 00210 (ZA 00221)



- Monocomando vasca-doccia incasso
- Single lever bath-shower mixer
- UP-Wannenfüll-u. Brausebatterie 1/2"
- Mitigeur bain/douche encastré

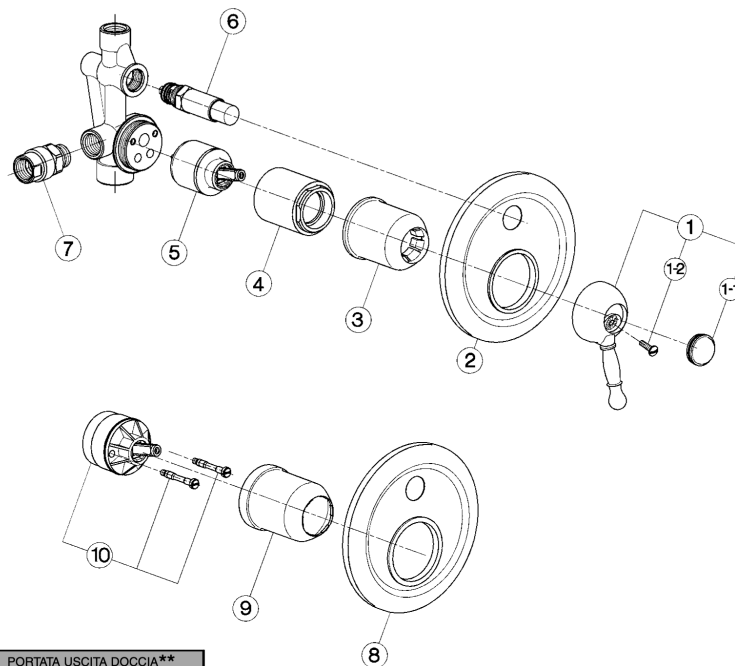

bar	PORTATA USCITA VASCA * BATH OUTLET FLOW RATE DURCHFLOß WANNE DEBIT BAIGNOIRE l/min.	PORTATA USCITA DOCCIA** SHOWER OUTLET FLOW RATE DURCHFLOß BRAUSE DEBIT DOUCHE l/min.
0,5	10	5,5
1	13,5	7,5
2	19	10,5
3	23	12,5
4	26,5	14,5
5	30	16

\* con resistenza silenziosa della classe di portata C (30 l/min. a 3 bar) / with hydraulic resistance of flow rate class C (30 l/min. at 3 bar)  
mit geräuscharmen Widerstand der Durchflussklasse C (30 l/min. bei 3 bar) / avec aérateur classe C (30 l/min. à 3 bar)

\*\* con resistenza silenziosa della classe di portata A (15 l/min. a 3 bar) / with hydraulic resistance of flow rate class A (15 l/min. at 3 bar)  
mit geräuscharmen Widerstand der Durchflussklasse A (15 l/min. bei 3 bar) / avec aérateur classe A (15 l/min. à 3 bar)

NR.	DESCRIZIONE DESCRIPTION BESCHREIBUNG DESCRIPTION	N. CODICE CODE NO. WERKSNR. NR. CODE	NR.	DESCRIZIONE DESCRIPTION BESCHREIBUNG DESCRIPTION	N. CODICE CODE NO. WERKSNR. NR. CODE	NR.	DESCRIZIONE DESCRIPTION BESCHREIBUNG DESCRIPTION	N. CODICE CODE NO. WERKSNR. NR. CODE
1	Leva monocomando "AY" Lever "AY" Hebel "AY" Levier "AY"	ZZ 90370 0	5	Cartuccia monocomando piccola Mixing valve - small size Kartusche Cartouche mitigeurs	ZZ 92909 0			
1-1	Piacchetta per leva "AY" Cap for lever "AY" Abdeckkappe f/Hebel "AY" Plaquette levier "AY"	ZZ 93048 0	6	Deviazione autom. per monocomando incasso Diverter for single lever mixer Umstellung fuer UP - EHM Inverseur mitigeur B/D	ZZ 92773 0			
1-2	Vite M.4,5x15 lb. tc. Screw M.4,5x15 Schraube M.4,5x15 Vis M.4,5x15	ZZ 92641 0	7	Raccordo silenziato per monoc.vasca incasso Silencer for conc. single lever bath mixer Schalldämpfer S-Anschluss Raccord silencieux	ZZ 92890 0			
2	Piastra monocomando incasso dev. automatica Plate single lever mixer Abdeckkassette f/UP Plaque B/D	ZZ 92913 0	8	Piastra monocomando incasso dev. automatica Plate single lever mixer Abdeckkassette f/UP Plaque B/D à encastrer	ZZ 92815 0			
3	Copricartuccia monocomando incasso Escutcheon concealed mixer Abdeckkappe f/UP-EHM Couvre-cartouche mitigeur encastré	ZZ 92720 0	9	Copricartuccia monocomando incasso Escutcheon concealed mixer Abdeckkappe f/UP-EHM Couvre-cartouche mitigeur encastré	ZZ 92705 0			
4	Cannotto bloccaggio cartuccia piccola Tube to fix cartridge Hüelse Bague x cartouche	ZZ 92664 0	10	Cartuccia monocomando con viti e adattatore Mixing valve Kartusche Cartouche mitigeurs	ZZ 90746 0			

AY.10

AY002100

<https://es.cisal.it/parte-externa-monomando-bano-ducha-empotrado-arcana-royal-ay002100>

## Parte empotrada monomando baño/ducha EMPOTRADO\_ZA002210

MODELO **ZA002210**

Parte empotrada monomando baño/ducha, desviador  
2 salidas 1/2" y 3/4", sin parte externa

ACABADOS DISPONIBLES



**04** 04 Sin acabado



CARACTERÍSTICAS

Recambio Cartucho **ZZ92909000**

Empotrado **1**

**Cartucho Monomando 43 mm**

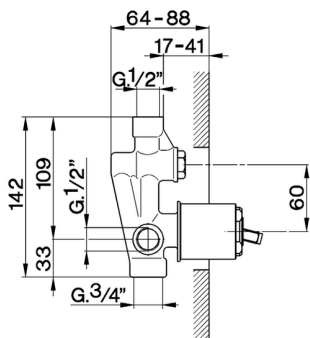

2026-04-30