

## Pareja de columnas de suelo COMPLEMENTOS\_ZA003830

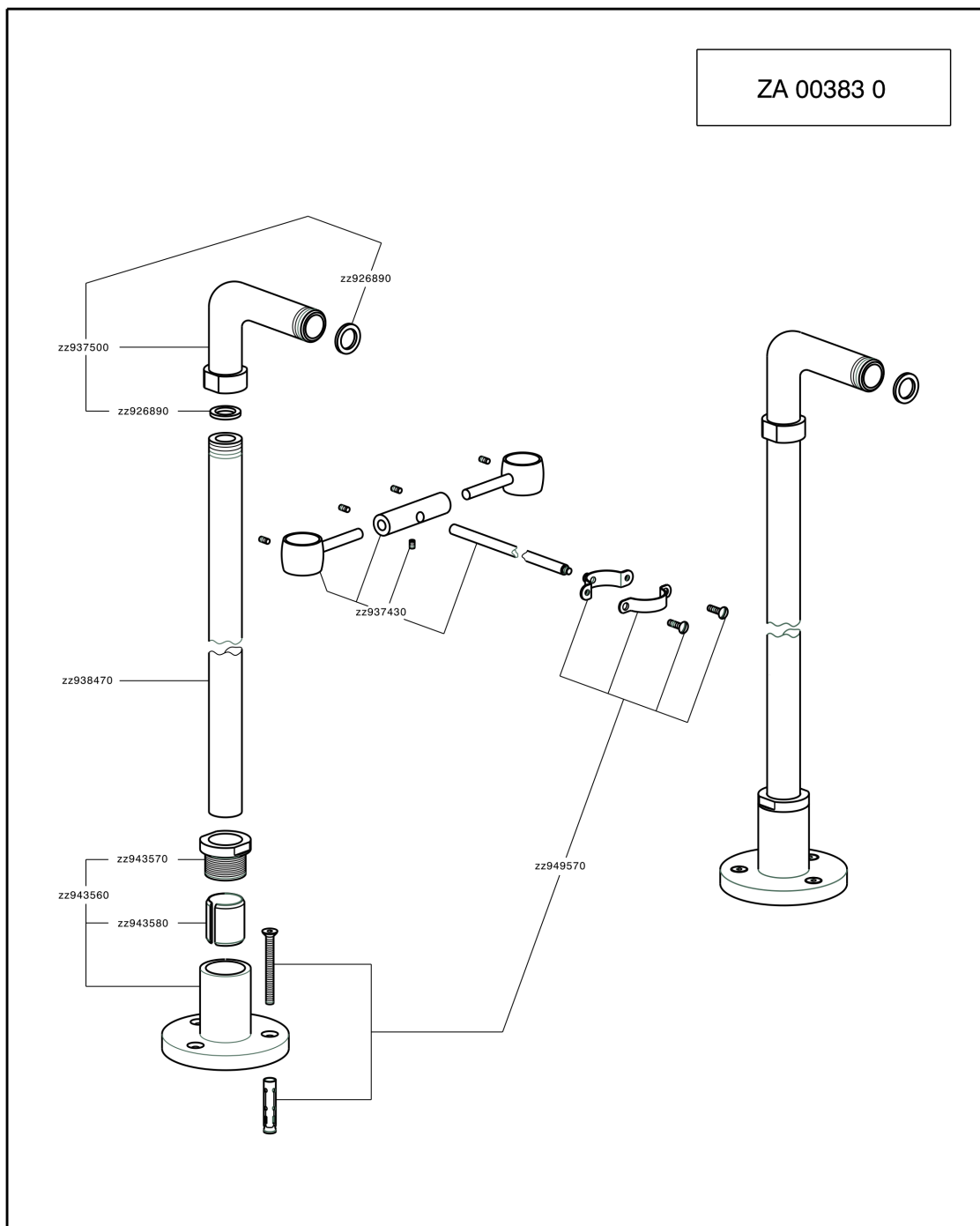

**cisal**  
RUBINETTERIA

Rubineria CISAL S.p.A.  
Via P. Durio, 160  
28010 Alzo di Pella (Novara) - Italia  
Tel. +39 0322 918111  
Fax +39 0322 269919  
E-mail: [cisal@cisal.it](mailto:cisal@cisal.it) - [www.cisal.it](http://www.cisal.it)

CISAL Sanitär Armaturen Vertriebs GmbH  
Gewerbstrasse, 6  
91452 Wilhelmsdorf - Deutschland  
Tel. +49 09102 9382-0  
Fax +49 09102 9382-92  
E-mail: [info@cisal.de](mailto:info@cisal.de) - [www.cisal.de](http://www.cisal.de)

### ACCESSORI - art. ZA 00383 0

Colonne da pavimento  
Floor column connections  
Raccords colonnettes au sol  
Standsauele  
Columnas de suelo

19.06.12

ZA003830

<https://es.cisal.it/pareja-de-columnas-de-suelo-complementos-za003830>

2026-05-03