

## Parte externa termostático ducha 2 funciones ROADSTER ACCENT\_RA01V200

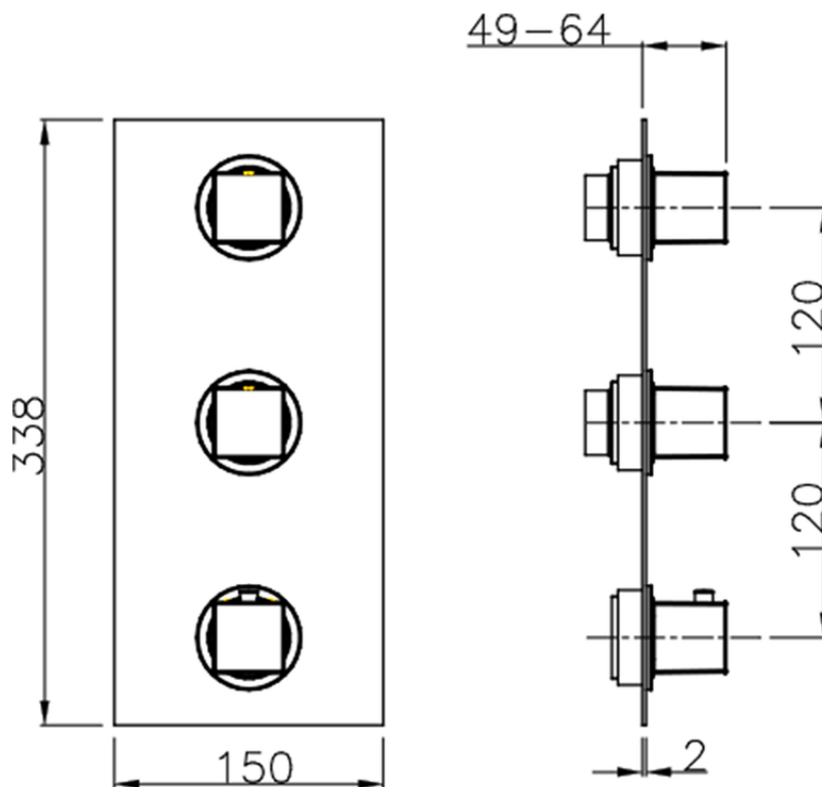

RA01V200

<https://es.cisal.it/parte-externa-termostatico-ducha-2-funciones-roadster-accent-ra01v200>

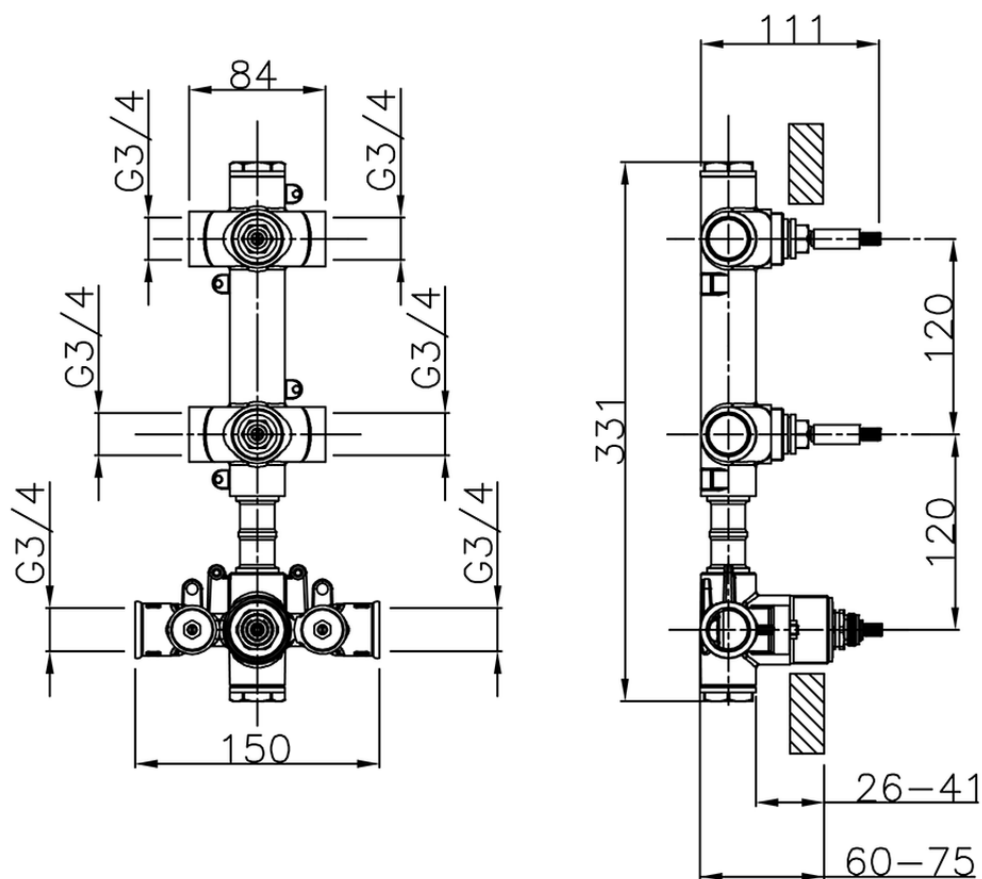

ZA01V200

<https://es.cisal.it/parte-empotrada-termostatico-ducha-2-funciones-empotrado-za01v200>

2025-01-15