







Conjunto ducha duplex ARCANA TOSCANA_TS003050

MODELO **TS003050**

Conjunto ducha duplex, soporte duchita articulado mural, duchita una función Toscana, flexible Latón 150 cm



ACABADOS DISPONIBLES

-  **21** 21 Cromo
-  **24** 24 Oro
-  **26** 26 Cobre Viejo
-  **27** 27 Bronce Viejo
-  **2A** 2A Niquel Satinado Cepillado
-  **74** 74 Cromo/Oro

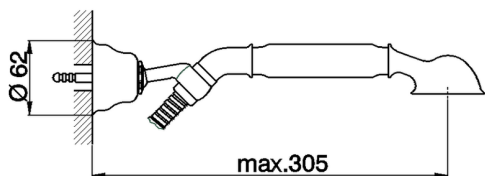

CARACTERÍSTICAS



Conjunto ducha duplex ARCANA TOSCANA_TS003050

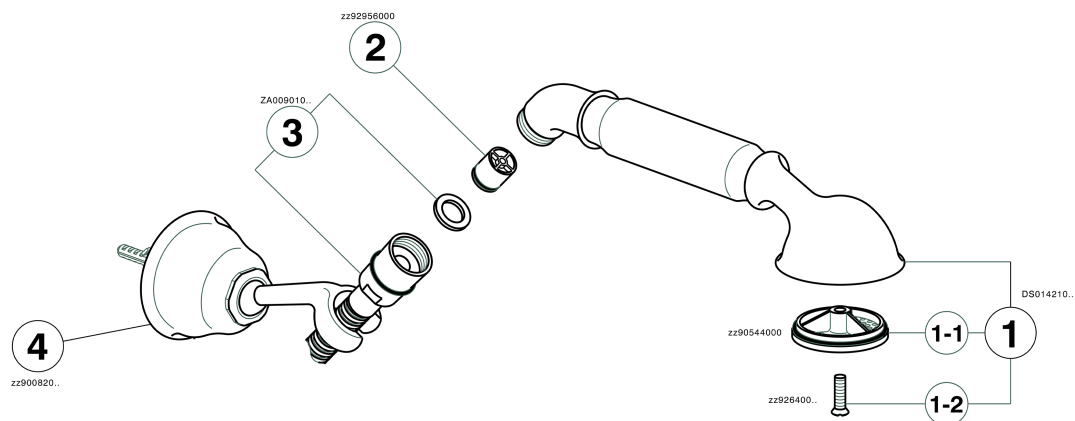

TS003050

<https://es.cisal.it/conjunto-ducha-duplex-arcana-toscana-ts003050>

2026-06-17