

## Columna monomando ducha 2 funciones TENDER\_C2004032

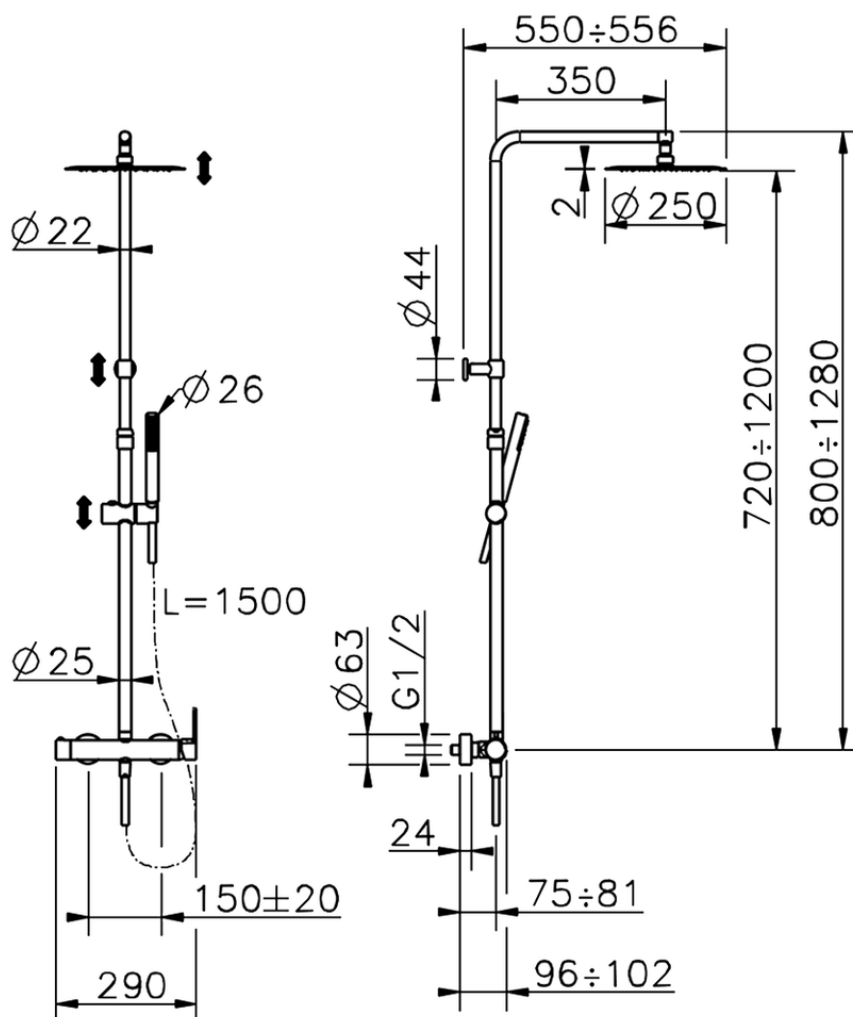

C2004032

<https://es.cisal.it/columna-monomando-ducha-2-funciones-tender-c2004032>

2026-04-30