

Parte externa monomando lavabo de pared LESS MINIMAL_LM005517

MODELO **LM005517**

Parte externa monomando lavabo de pared, sin parte empotrada, para art. Easy-Box ZA002450-ZA025510

ACABADOS DISPONIBLES

-  **21** 21 Cromo
-  **2F** 2F Niquel Cepillado
-  **40** 40 Negro Mate
-  **4Q** 4Q Blanco Mate

CARACTERÍSTICAS

Instalación **Empotrado**
 Empotrado 1 **ZA002450**

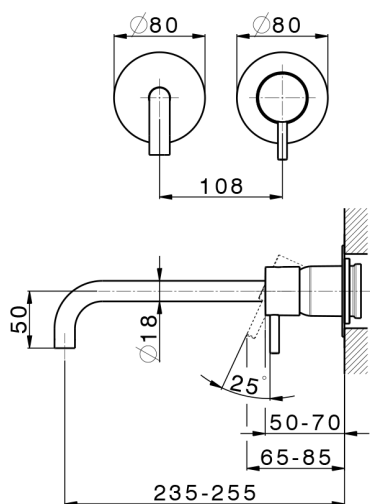
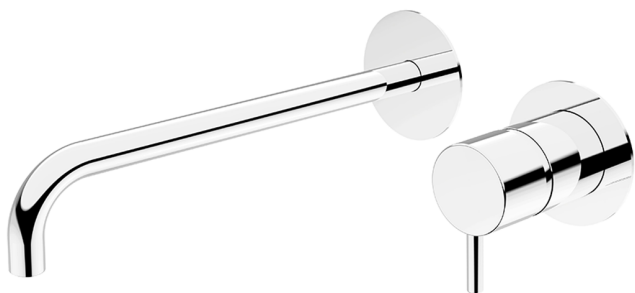

Parte externa monomando lavabo de pared LESS MINIMAL_LM005517

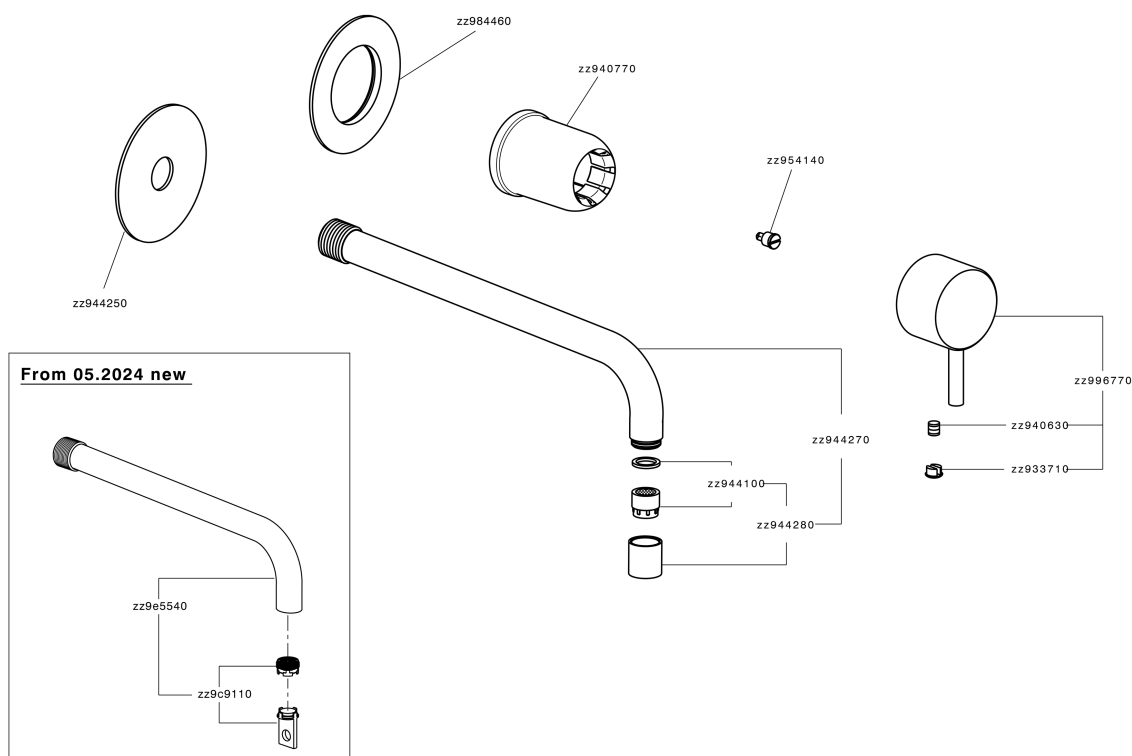

LM005517

<https://es.cisal.it/parte-externa-monomando-lavabo-de-pared-less-minimal-lm005517>

2026-06-14