

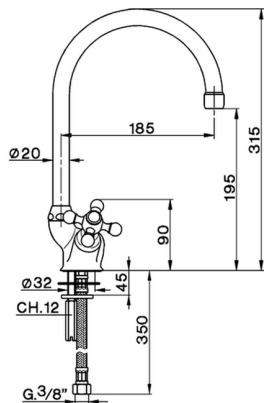





Fregadero ARCANA CERAMIC_AC000530



MODELO **AC000530**

Fregadero,caño giratorio

ACABADOS DISPONIBLES

- 
21 21 Cromo
- 
24 24 Oro
- 
26 26 Cobre Viejo
- 
27 27 Bronce Viejo
- 
2A 2A Niquel Satinado Cepillado
- 
74 74 Cromo/Oro

CARACTERÍSTICAS



Fregadero ARCANA CERAMIC_AC000530

cisal

AC 00052 (AC 00053)



- Monoforo lavabo
- Single hole basin mixer
- Einloch-Waschtischbatterie
- Mélangeur monotrou lavabo

bar	PORTATA BOCCA DI EROGAZIONE * SPOUT FLOW RATE DURCHFLOSS WANNENEINLAUF DÉBIT BEC DÉVERSEUR l/min.
0,5	9,5
1	13
2	18,5
3	22,5
4	26
5	29

* con resistenza silenziosa della classe di portata B (25,2 l/min. a 3 bar)
with hydraulic resistance of flow rate class B (25.2 l/min. at 3 bar)
mit geräuscharmen Widerstand der Durchflussklasse B (25.2 l/min. bei 3 bar)
avec aérateur classe B (25.2 l/min. à 3 bar)

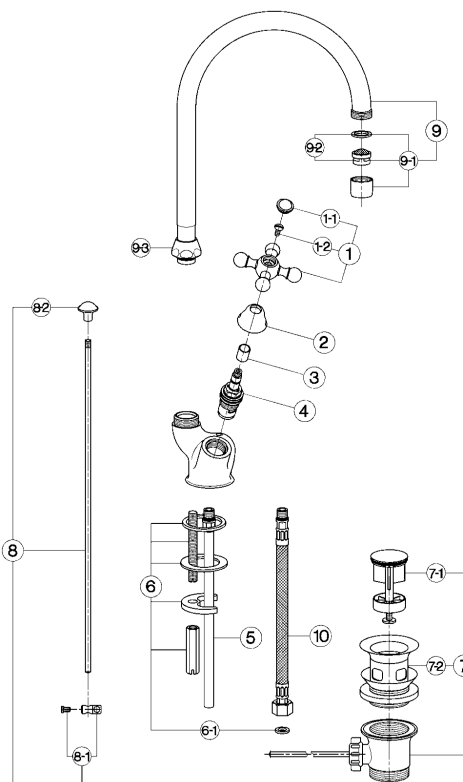

NR.	DESCRIZIONE DESCRIPTION BESCHREIBUNG DESCRIPTION	N. CODICE CODE NO. WERKSNR. NR. CODE	NR.	DESCRIZIONE DESCRIPTION BESCHREIBUNG DESCRIPTION	N. CODICE CODE NO. WERKSNR. NR. CODE	NR.	DESCRIZIONE DESCRIPTION BESCHREIBUNG DESCRIPTION	N. CODICE CODE NO. WERKSNR. NR. CODE
1	Maniglia "AR" con vite e placchetta Handle with screw and plate "AR" Griff "AR" mit Schraube und Abdeckkappe Croisillon avec vis et plaque "AR"	ZZ 90307 0	7	Scarico automatico 1" 1/4 sabbato Pop-up waste 1" 1/4 Ablaufgarnitur 1" 1/4 Vidage automat. 1"1/4	ZZ 92754 0	9-3	Calotta 3/4" es.29 Ø19,5 Nut 3/4" Ø19,5 Mutter 3/4" Ø19,5 Ecrou 3/4" Ø19,5	ZZ 92615 0
1-1	Placchetta a vite maniglia "AR" Cap for handle "AR" Abdeckkappe "AR" Griff Plaque cache - vis croisé. "AR"	ZZ 92617 0	7-1	Tappo completo scarico automatico 1" 1/4 Plug for pop-up waste 1" 1/4 Stöpln f/Abflussg. kpl 1" 1/4 Bonde - vidage 1"1/4	ZZ 92925 0	10	Flessibile M.11x1 3/8" F.L.365 Flex M.11x1 3/8" L.365 Anschlusschlauch M.11x1 3/8" L.365 Flex M.11x1 3/8" L.365	ZZ 92842 0
1-2	Vite M.4,5x10 tb. tc. zigrinata Screw M.4,5x10 Schraube M.4,5x10 Vis M.4,5x10	ZZ 92609 0	7-2	Piletta per scarico automatico 1" 1/4 Waste for bath drain 1" 1/4 Ablauf / Abflussgarnitur 1" 1/4 Crépine pour vidage 1" 1/4	ZZ 92924 0			
2	Cappuccio coprivite Ø32 H.21 "AC" Escutcheon Ø32 H.21 "AC" Abdeckkappe Ø32 H.21 "AC" Rosace couvre-tête Ø32 H.21 "AC"	ZZ 92652 0	8	Astina scarico completa Ø6 Rod Ø6 Zugstange Ø6 Tige Ø6	ZZ 92760 0			
3	Tubetto copriasta "AR" H.15,5 Sliding cover tube "AR" H.15,5 Abdeckkappe Oberteil "AR" H.15,5 Tube couvre-tête "AR" H.15,5	ZZ 92619 0	8-1	Morsetto astina scarico automatico Ø6,2 Connection for pop-up rod Ø6,2 Gelenkstueck f/Zugstange Ø6,2 Jonction x tige vidage Ø6,2	ZZ 92622 0			
4	Vitona ceramico DX per monotori e gruppi "AC" Ceramic headvalve 1/2" right "AC"-short Keramikkoberteil 1/2"-rechts-"AC"-kurz Tête céramique 1/2" droite "AC"- courte	ZZ 92858 0	8-2	Pomolo per scarico automatico "AR" Knob for pop-up rod "AR" Zugknopf f/Abflussgarn. "AR" Pommeau - tige "AR"	ZZ 92624 0			
5	Tubetto monotoro "SU" con O.R. Tube with O.R. "SU" Anschlussrohr mit O.R. "SU" Tube "SU" avec O.R.	ZZ 92838 0	9	Canna alta Ø20 interasse 185 Swinging spout 185 Ø20 Auslauf-Rohr-schwenkbar-185 Ø20 Bec orientable 185 Ø20	ZZ 90124 0			
6	Set installazione monocomando monoforo Installation set single hole Befestigungssat Set Installation	ZZ 92851 0	9-1	Aeratore M.22x1 IB Mousseur M.22x1 IB Perlator M.22x1 IB Mousseur M.22x1 IB	ZZ 92841 0			
6-1	Guarnizione fibra 3/8" Gasket rubber 3/8" Fiberring 3/8" Joint en fibre 3/8"	ZZ 92696 0	9-2	Ceramica per aeratore M. 22x1 Mousseur cartridge M.22x1 Kart. f/Perlator M.22x1 Cartouche x mousseur M.22x1	ZZ 92703 0			

AC.7

AC000530

<https://es.cisal.it/fregadero-arcana-ceramic-ac000530>

2026-06-17